

Smith Meter® Truck Meter Packages

Bulletin SS01095 Issue/Rev. 0.5 (4/18)

Smith Meter® PD Meters

Smith Meter® Truck Meter Packages are versatile because of their modular design and arrangement flexibility.

Truck meter package options are made by combining various components. These consist of a meter, counter, air eliminator strainer, faucet, preset counter, and ticket printer.

The primary functions of metering product and registering volume are performed by a rotary vane positive displacement meter and large numeral counter. Other modular features can be easily added as simple bolt on items to meet customer requirements.

The air elimination feature will sense slugs of air approaching the meter and vent them. This will keep the meter packed with fluid, preventing erroneous measurement. A strainer is an integral part of the air eliminator which will remove contaminants from the line.

The faucet is a valve that starts and stops flow and can be incorporated with the preset counter to automatically deliver and shut off the delivered batch (one person operation).

A ticket printer will provide receipt of the registered quantity delivered.

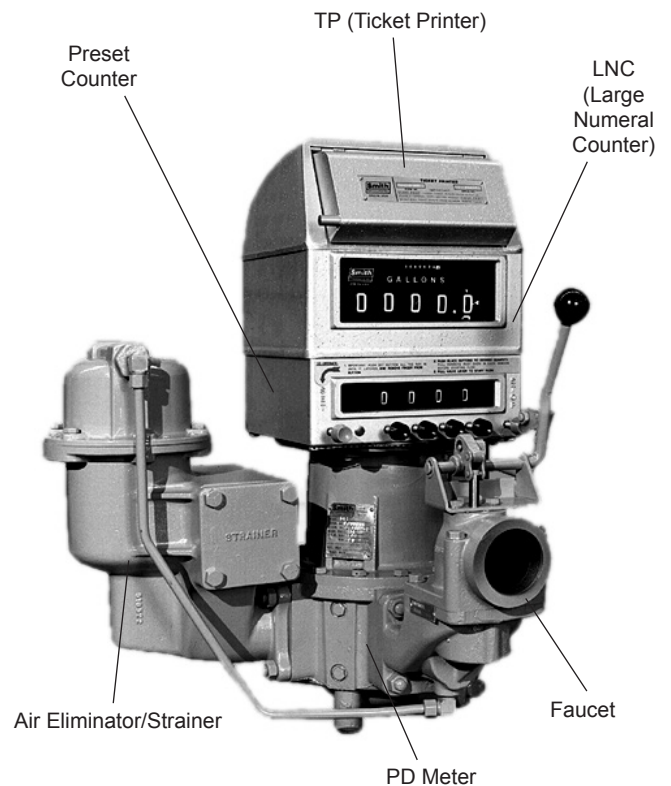

Features

- **A wide range of products** from gasoline to kerosene to fuel oils can be metered.
- **Compact, versatile design** can be readily fit into nearly all installations.
- **Low pressure drop meter** results in low meter slippage and thus superior meter accuracy.
- **Responsive air release and air check** prevents metering of air on split compartment deliveries.
- **Simple, rugged calibrator** is externally adjusted with a screwdriver and easily sealed to prevent unauthorized tampering.
- **High-capacity, low pressure drop strainer** built into the air eliminator with easy accessibility for cleaning.

Meter Selection Guide

Model	Max Flow		Max Pressure		See Page
	(GPM)	(LPM)	(psig)	(kPa)	
T-11	100	375	150	1034	3
T-20	200	750	150	1035	5
T-40	400	1500	75	517	7

Individual Component Descriptions

Positive Displacement Meter (PD Meter) (2" T-11, 3" T-20, 4" T-40)

Smith Meter® positive displacement truck meters are rotary vane, single-case, angle-type meters. A single-case outer housing forms part of the measuring chamber. The angle-type meter has the inlet 90 degrees from the outlet. Blades that function as part of an internal rotor extend and retract from the rotor as it turns about a fixed cam. The extended blades isolate and measure exact amounts of volume of product passing through the meter. Neither blades nor rotor contact the stationary walls of the measuring chamber, resulting in low pressure drop and long life.

Large Numeral Counter (LNC)

The counter provides a method of registering the volume delivered. The large numeral display can be cleared (reset) while the smaller display totalizer (non-reset) permanently records the total. A selection of unit designations are available, GALLONS, LITERS, etc.

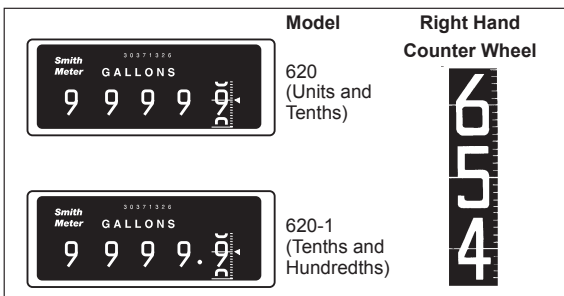

Large Numeral Counter with Ticket Printer (LNC/TP)

With the addition of a ticket printer to the counter described above, the “accurately measured” volume can be recorded on a ticket and presented to the customer. The tamper-proof system seals the ticket into the printer while delivery is being made, also sealing out dirt and weather. The ticket is mechanically printed before it can be removed from the printer.

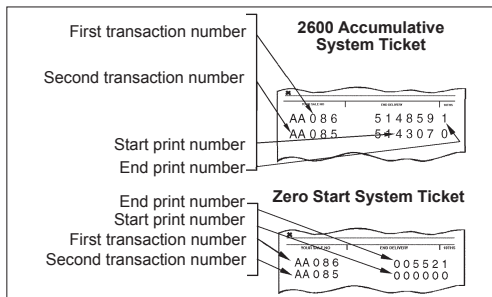

2600 Accumulative System Ticket – Delivery output is obtained by subtracting Start Print from Finish Print.

Zero Start System Ticket – Finish Print number is the actual volume delivered.

* See Bulletin [AB01026](#) “PBSSC/LNC/TP – Adaptation Guide” for details on counter gearing and options

* To properly operate the T4A air eliminator, compressed air at 40 psig ± 5 psig is required. Consumption is approx. 0.15 std. cu.ft. for a standard delivery.

Two-Stage 5 Button Preset Counter (PRESET)*

A push button set-stop counter, along with a set-stop faucet, automatically controls the amount delivered. The batch size is set on the counter and then the faucet handle, linked to the counter, is pulled to start the flow. As the completion of the batch approaches, at a pre-determined and set remaining volume (first trip), the preset counter trips, allowing the faucet to partially close (low flow), practically closing the faucet and slowing the flow of product. As the preset counter, which counts downward from the initially set volume or batch, reaches zero (final trip), the faucet closes completely.

Air Eliminator/Strainer (2" T2A, 3" T3A, 4" T4A*)

The air eliminator, located upstream of the meter, allows air to collect and then discharges it to provide accurate liquid registration. As the air collects, an internal float drops, eventually signalling an air vent to open and a butterfly or back-pressure valve to reduce or stop the flow of liquid during the venting. The T2A air eliminator utilizes (depending upon the application) either a separate back-pressure valve or one which is integral with the faucet. For the T3A and T4A, linkage connects the float and a butterfly in the eliminator outlet. As the air is driven out of the vessel, the float rises with the liquid, eventually closing the vent and increasing the flow back to its normal rate.

A strainer is part of the air eliminator assembly. A 40 mesh screened basket removes particles in the product. The strainer basket is removable for cleaning.

XR2 – Back Pressure Valve

A separate back pressure valve can be used with the T11 meter/T2A air eliminator combination, or one which is an integral part of MP2S and SP2S faucets. In either case, it slows the product flow to allow the air eliminator to release the trapped air. The piston in this valve is operated by the air present in the T2A eliminator. Once the air has been vented, the piston allows the flow through the meter to return to normal.

2½" Air Sense Back Pressure Valve

This optional back pressure valve can be used to enhance air elimination efficiency with T20/T3A pressure systems.

Faucet

Manual

MP2S, MPG2-Faucet 2"
MPG3-Faucet 3"
MG4-Faucet 4"

Set Stop

SP2S, SPG2-Faucet 2"
SPG3-Faucet 3"
SG4-Faucet 4"

Faucets start and stop the delivery of product. Manually operated faucets require the handle to be moved to start and stop the flow of product. Faucets with the set-stop linkage connected to the preset counter are manually started but will automatically close in two stages at the end of a batch. Two stage closure consists of slowing the flow rate near the end of the batch and then closing the valve completely as the preset counter counts down to and reaches zero.

T-11 Meter Packages



T-11 Meter with T2A Air Eliminator, SP2S Faucet, Preset Counter, Counter, and Ticket Printer – Model T11 P-Z

Operating Specifications

- Maximum Viscosity:** 50 mPa·s (250 SSU)
- Temperature:** -20°F to 150°F (-29°C to 65°C)
- Maximum Flow Rate:** 100 USGPM (375 L/min)
- Maximum Pressure:** 150 PSIG (1034 kPa)
- Pressure Drop (ΔP)**

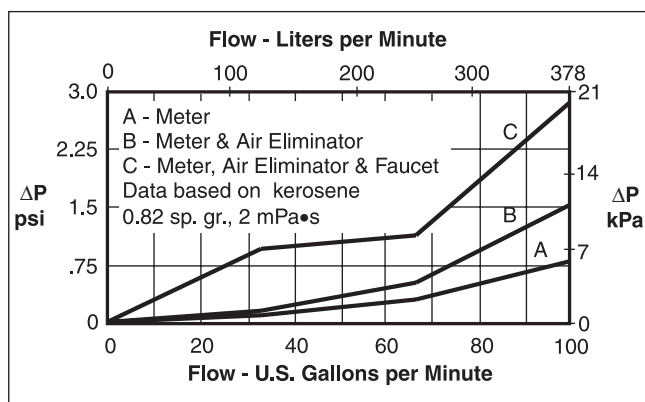

Pressure Drop Correction for Other Products

To determine the pressure drop for other products, multiply the ΔP from the chart by the correction factor shown below.

	Specific Gravity	Viscosity (mPa·s)	Correction Factor
Gasoline	0.5	0.7	0.63
Fuel Oil	0.9	10	1.6
Fuel Oil #2	0.9	20	1.9

Typical range and linearity for various products

T-11 Meter with Standard Clearances, Counter, and Ticket Printer				
Linearity	Product and Viscosity			Units (mPa·s)
	Gasoline 0.7	Kerosene/Diesel 2.0	Fuel Oil ≥ 10	
$\pm 0.15\%$	20-100	10-100	5-100	(GPM)
	75-378	38-378	19-378	(L/min)
$\pm 0.25\%$	15-100	7-100	3-100	(GPM)
	57-378	26-378	11-378	(L/min)

T-11 Meter with Low Flow Clearances, Counter, and Ticket Printer				
Linearity	Product and Viscosity			Units (mPa·s)
	Gasoline 0.7	Kerosene/Diesel 2.0	Fuel Oil ≥ 10	
$\pm 0.15\%$	10-100	5-100	2-100	(GPM)
	38-378	19-378	8-378	(L/min)
$\pm 0.25\%$	8-100	4-100	1-100	(GPM)
	30-378	15-378	4-378	(L/min)

Dimensions

Inches (mm) – For Model T11 P-Z*

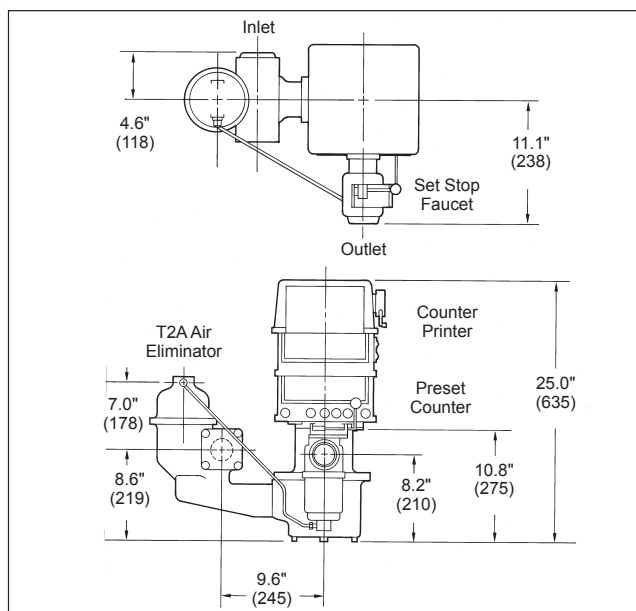

Materials of Construction

	Housing	Internals	Seals
T-11 2" Meter	Cast Iron	Iron, Steel, Stainless Steel, Aluminum, Bronze	Cover O-Ring Std. – Buna-N Opt'l. – Viton Packing Gland Std. – Buna Opt'l. – Viton or PTFE ⁹
T2A and T3A Strainer (40 mesh)	Aluminum Iron Flange	Steel, Aluminum	Std. – Buna Opt'l. – Viton
XR-2 Air Back Pressure Valve	Cast Iron	Cast Iron, Steel, Stainless Steel, Aluminum	Viton
MP2S, MPG2, SP2S, SPG2 2" Faucets	Cast Iron	Steel, Cast Iron, Aluminum	Std. – Buna Opt'l. – Viton

9 Polytetrafluoroethylene (PTFE).

T-11 Meter Package Selection Guide

Modeling

Example: T11 — P — T — BB — D — B

Meter Model¹

T11 – 2"

System Flow

P – Pressure
G – Gravity

Meter Package⁸

- X – Air Eliminator/Strainer, Large Numeral Counter/Ticket Printer (LNC/TP)
- R – Air Eliminator/Strainer, Large Numeral Counter
- V – Air Eliminator/Strainer, Large Numeral Counter/Ticket Printer, Manual Faucet
- P – Air Eliminator/Strainer, Large Numeral Counter, Manual Faucet
- Z – Air Eliminator/Strainer, Large Numeral Counter/Ticket Printer, Preset Counter, Set Stop Faucet
- T – Air Eliminator/Strainer, Large Numeral Counter, Preset Counter, Set Stop Faucet

Arrangement³

- A – Standard
- B
- C
- D

Meter and LNC Registration

- G – Gallons⁴
- D – Dekaliters^{5,6}
- L – Liters^{5,7}

Elastomers

- BB – Buna-N/Buna-N¹
- VV – Viton/Viton²

Connections: Female NPT threaded end connection.

Pressure Rating: Maximum working pressure of all meters and components (except T-40 arrangements) is 150 psig (1,034 kPa) at 100°F (65°C).

Inlet/Outlet Position Arrangements

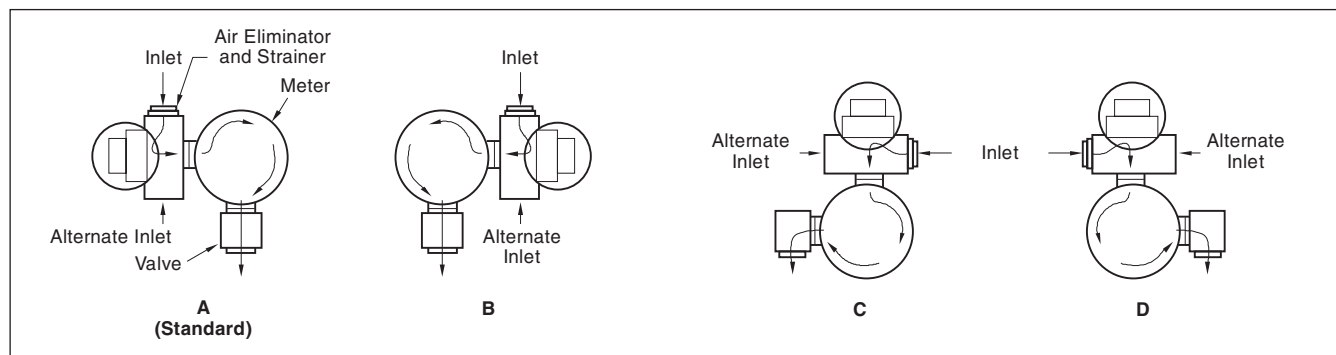

Meters will be set up as indicated by Arrangement "A" unless otherwise specified.

- 1 Buna-N packing gland, Buna-N accessories.
- 2 Viton packing gland, Viton accessories.
- 3 All meter packages will be supplied with arrangement (A) unless otherwise specified.
- 4 All LNC's with ticket printers will be 6600 Series with zero start ticket printer and will register in tenths on the first right hand wheel.
- 5 Dekaliter and Liter LNC with ticket printer will have accumulative ticket printer and LNC will register in whole units unless otherwise specified.
- 6 Meter gearing is Dekaliter, LNC will register in Dekaliters.
- 7 Meter gearing is Dekaliter, LNC will register in Liters.
- 8 For Large Numerical Counters and Printer Model Designation, Reference Counter Selection Guide Bulletin [AB01024](#).

T-20 Meter Packages



T-20 Meter with T3A Air eliminator, SPG3 Faucet, Preset Counter, Counter, and Ticket Printer – Model T20-Z

Operating Specifications

- Maximum Viscosity:** 50 mPa·s (250 SSU)
- Temperature:** -20°F to 150°F (-29°C to 65°C)
- Maximum Flow Rate:** 200 USGPM (750 L/min)
- Maximum Pressure:** 150 PSIG (1034 kPa)
- Pressure Drop (ΔP)**

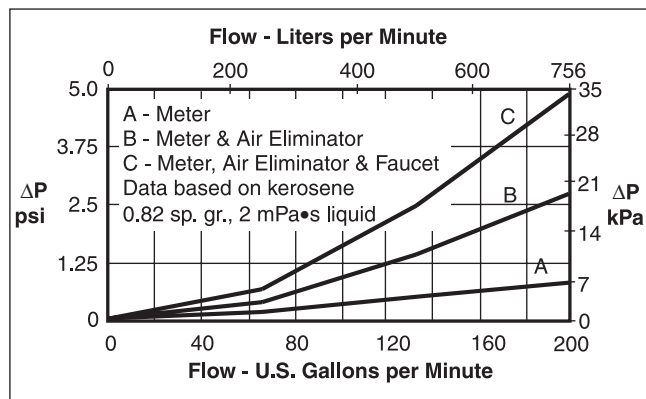

Pressure Drop Correction for Other Products

To determine the pressure drop for other products, multiply the ΔP from the chart by the correction factor shown below.

	Specific Gravity	Viscosity (mPa·s)	Correction Factor
Gasoline	0.5	0.7	0.63
Fuel Oil	0.9	10	1.6
Fuel Oil #2	0.9	20	1.9

9 Polytetrafluoroethylene (PTFE).

Typical Range and Linearity for Various Products

T-20 Meter with Standard Clearances, Counter, and Ticket Printer

Linearity	Product and Viscosity			Units (mPa·s)
	Gasoline 0.7	Kerosene/Diesel 2.0	Fuel Oil ≥ 10	
$\pm 0.15\%$	40-200	20-200	10-200	(GPM)
	151-757	76-757	38-757	(L/min)
$\pm 0.25\%$	30-200	15-200	6-200	(GPM)
	114-757	57-757	23-757	(L/min)

T-20 Meter with Low Flow Clearances, Counter, and Ticket Printer

$\pm 0.15\%$	20-200	10-200	4-200	(GPM)
	76-757	38-757	15-757	(L/min)
$\pm 0.25\%$	15-200	8-200	2-200	(GPM)
	57-757	30-757	8-757	(L/min)

Dimensions

Inches (mm) – For Model T20-Z*

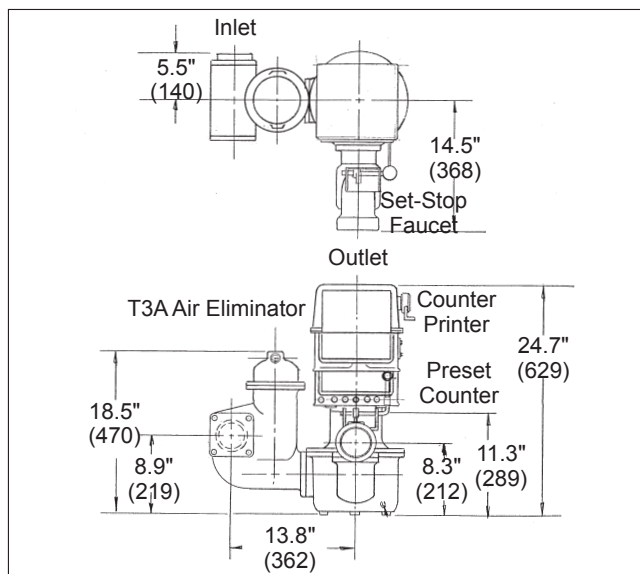

Materials of Construction

	Housing	Internals	Seals
T-20 3" Meter	Cast Iron	Iron, Steel, Stainless Steel, Aluminum, Bronze	Std. – Buna-N Opt'l. – Viton Packing Gland Std. – Buna Opt'l. – Viton or PTFE ⁹
T3A Air Eliminator/Strainer (40 mesh)	Aluminum with Steel Flange	Steel, Stainless Steel, Aluminum	Std. – Buna Opt'l. – Viton
MPG3 and SPG3 3" Faucets	Aluminum	Steel, Iron, Aluminum	Std. – Buna Opt'l. – Viton

T-20 Meter Package Selection Guide

Modeling

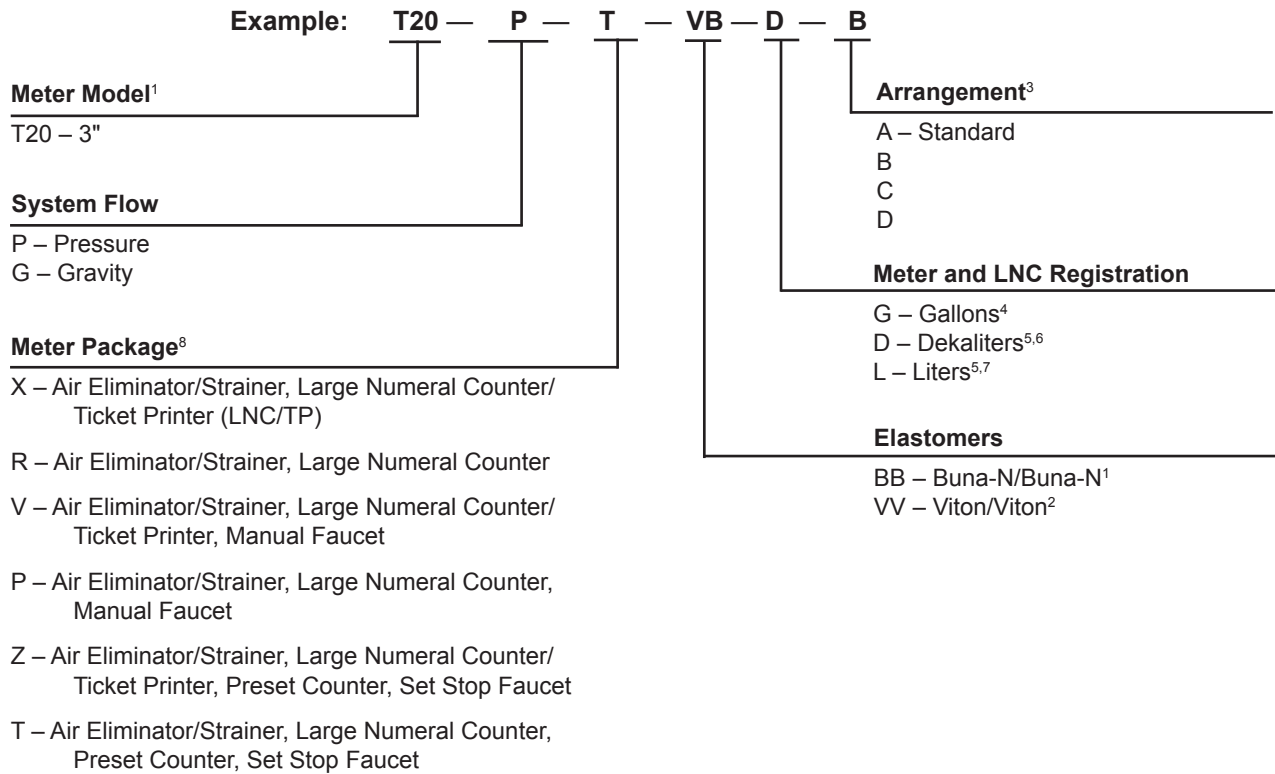

Connections: Female NPT threaded end connection.

Pressure Rating: Maximum working pressure of all meters and components (except T-40 arrangements) is 150 psig (1,034 kPa) at 100°F (65°C).

Inlet/Outlet Position Arrangements

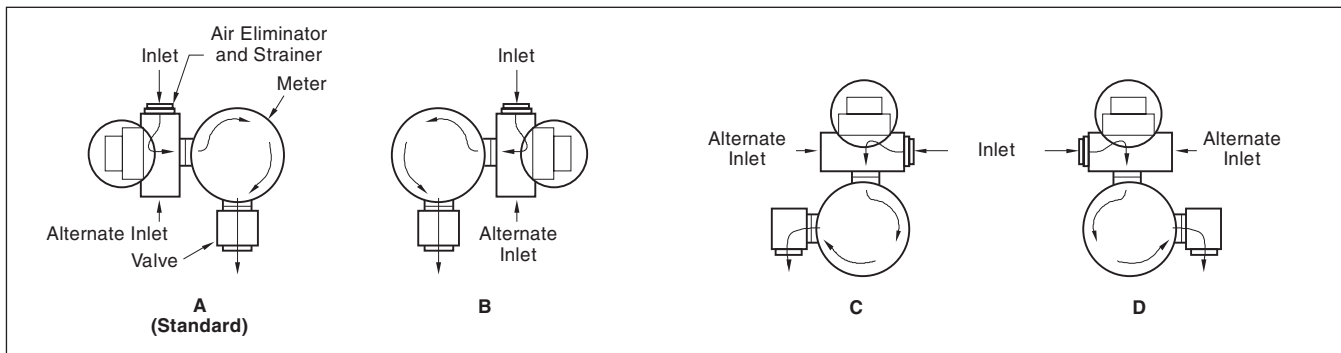

Meters will be set up as indicated by Arrangement "A" unless otherwise specified.

1 Buna-N packing gland, Buna-N accessories.
 2 Viton packing gland, Viton accessories.
 3 All meter packages will be supplied with arrangement (A) unless otherwise specified.
 4 All LNC's with ticket printers will be 6600 Series with zero start ticket printer and will register in tenths on the first right hand wheel.
 5 Dekaliter and Liter LNC with ticket printer will have accumulative ticket printer and LNC will register in whole units unless otherwise specified.
 6 Meter gearing is Dekaliter, LNC will register in Dekaliters.
 7 Meter gearing is Dekaliter, LNC will register in Liters.
 8 For Large Numerical Counters and Printer Model Designation, Reference Counter Selection Guide Bulletin [AB01024](#).

T-40 Gravity Meter Packages

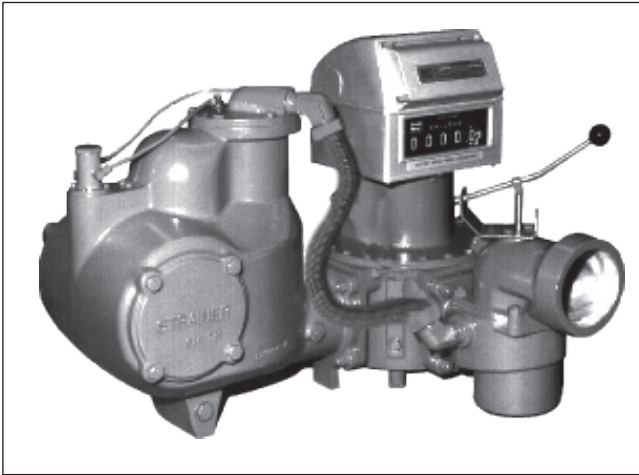

T-40 Meter with T4A Air Eliminator, MG4 Faucet, Counter, and Ticket Printer – Model T40-V

Operating Specifications

- Maximum Viscosity:** 50 mPa•s (250 SSU)
- Temperature:** -20°F to 150°F (-29°C to 65°C)
- Maximum Flow Rate:** 400 USGPM (1500 L/min)
- Maximum Pressure:** 36 PSIG (250 kPa)
- Pressure Drop (ΔP)**

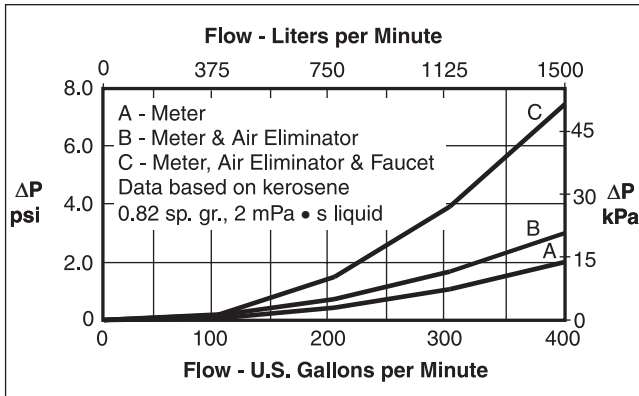

Pressure Drop Correction for Other Products

To determine the pressure drop for other products, multiply the ΔP from the chart by the correction factor shown below.

	Specific Gravity	Viscosity (mPa•s)	Correction Factor
Gasoline	0.5	0.7	0.63
Fuel Oil	0.9	10	1.6
Fuel Oil #2	0.9	20	1.9

9 Polytetrafluoroethylene (PTFE).

Typical Range and Linearity for Various Products

T-40 Meter with Standard Clearances, Counter, and Ticket Printer				
Linearity	Product & Viscosity			Units (mPa•s)
	Gasoline 0.7	Kerosene/Diesel 2.0	Fuel Oil ≥ 10	
$\pm 0.15\%$	80-400	40-400	20-400	(GPM)
	303-1514	151-1514	76-1514	(L/min)
$\pm 0.25\%$	60-400	28-400	12-400	(GPM)
	227-1514	106-1514	45-1514	(L/min)
T-40 Meter with Low Flow Clearances, Counter, and Ticket Printer				
$\pm 0.15\%$	40-400	20-400	8-400	(GPM)
	151-1514	76-1514	30-1514	(L/min)
$\pm 0.25\%$	32-400	16-400	4-400	(GPM)
	121-1514	60-1514	15-1514	(L/min)

Dimensions

Inches (mm) – For Model T40-Z*

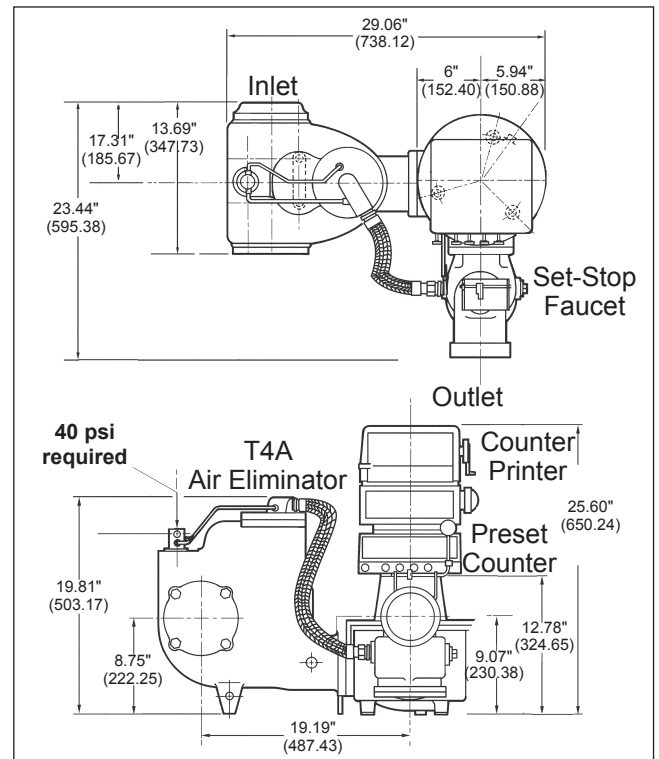

Materials of Construction

	Housing	Internals	Seals
T-40 4" Meter	Cast Iron	Iron, Steel, Stainless Steel, Aluminum, Bronze	Std. – Buna-N Opt'l. – Viton Packing Gland Std. – Buna Opt'l. – Viton or PTFE ⁹
T4A Air Eliminator	Aluminum with Steel Strainer (40 mesh) Flange	Steel, Stainless Steel, Aluminum	Std. – Buna Opt'l. – Viton
MG4 & SG4 Faucets	Aluminum	Steel, Iron, Aluminum	Std. – Buna Opt'l. – Viton

T-40 Meter Gravity Package Selection Guide

Modeling

Example: T40 — G — T — VB — D — B

Meter Model¹

T40 – 4"

System Flow

G – Gravity

Meter Package⁸

X – Air Eliminator/Strainer, Large Numeral Counter/
Ticket Printer (LNC/TP)

R – Air Eliminator/Strainer, Large Numeral Counter

V – Air Eliminator/Strainer, Large Numeral Counter/
Ticket Printer, Manual Faucet

P – Air Eliminator/Strainer, Large Numeral Counter,
Manual Faucet

Z – Air Eliminator/Strainer, Large Numeral Counter/
Ticket Printer, Preset Counter, Set Stop Faucet

T – Air Eliminator/Strainer, Large Numeral Counter,
Preset Counter, Set Stop Faucet

Arrangement³

A – Standard

B

C

D

Meter and LNC Registration

G – Gallons⁴

D – Dekaliters^{5,6}

L – Liters^{5,7}

Elastomers

BB – Buna-N/Buna-N¹

VV – Viton/Viton²

Connections: Female NPT threaded end connection.

Pressure Rating: Maximum working pressure of all meters and components (except T-40 arrangements) is 150 psig (1,034 kPa) at 100°F (65°C).

Inlet/Outlet Position Arrangements

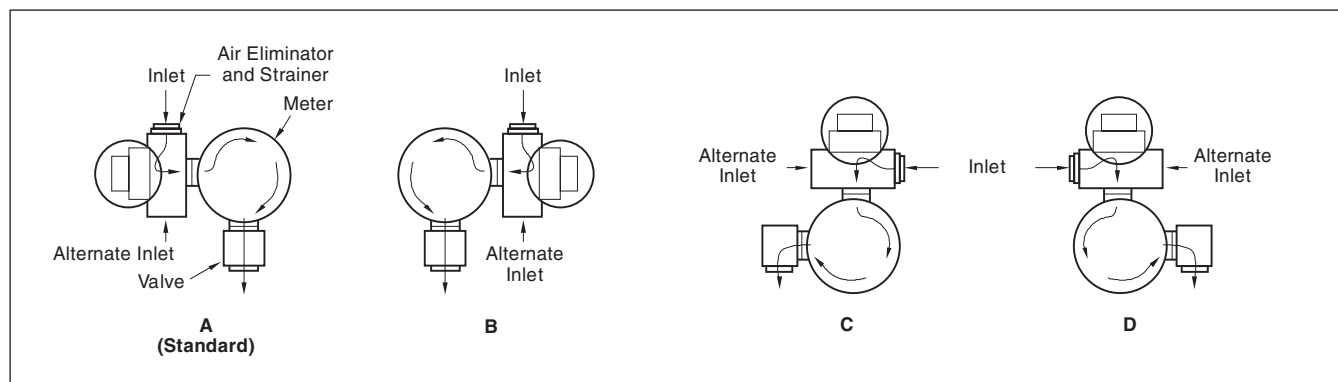

Meters will be set up as indicated by Arrangement "A" unless otherwise specified.

1 Buna-N packing gland, Buna-N accessories.

2 Viton packing gland, Viton accessories.

3 All meter packages will be supplied with arrangement (A) unless otherwise specified.

4 All LNC's with ticket printers will be 6600 Series with zero start ticket printer and will register in tenths on the first right hand wheel.

5 Dekaliter and Liter LNC with ticket printer will have accumulative ticket printer and LNC will register in whole units unless otherwise specified.

6 Meter gearing is Dekaliter, LNC will register in Dekaliters.

7 Meter gearing is Dekaliter, LNC will register in Liters.

8 For Large Numerical Counters and Printer Model Designation, Reference Counter Selection Guide Bulletin [AB01024](#).

Revisions included in SS01095 Issue/Rev. 0.5 (4/18):

New company branding.

The specifications contained herein are subject to change without notice and any user of said specifications should verify from the manufacturer that the specifications are currently in effect. Otherwise, the manufacturer assumes no responsibility for the use of specifications which may have been changed and are no longer in effect.