

Communication Interface **EMIS4**



Further documentation for this product:

Name	Order no.
EMIS/MultiTask GE – software operating instructions Communication formats – 411/FTL/FAS/TDL	MN F19 002 GE/DOK-558

Documentation on the internet:

info.smithmeter.com/literature/online_index.html

History

Revision	Date	Edited by	Status	Description
Rev. 1.00	April 2014	RA/RL/jp	Release	Basic edition
Rev. 1.02	June 2022	RL	Release	"Monitoring" supplemented
Rev. 1.03	July 2023	RL	Release	Additional Monitoring parameter Selectable Order/Customer-Nr in MTR file
Rev. 1.04	February 2024	RL	Release	Network definition for module R412

Table of Contents (English)

Table of Contents (English)	3
1 List of References	7
2 General Information	8
2.1 Orientation Aids for the Manual	8
2.2 Safety Information	9
2.2.1 Please Note	9
2.2.2 Disposal	9
2.2.2.1 Disposal of the Function Group or System	9
2.2.3 Intended Use	9
3 General Installation Information	11
3.1 Precautionary Measures	11
3.1.1 For Preventing Accidents (Due to Potential Gas Ignition)	11
3.1.2 To Ensure Compliance with Standards	11
3.1.3 To Ensure Fault-Free Operation	12
3.1.4 To Make Work Easier for the Service Team	12
3.2 Cable Routing in the Vehicle	13
3.3 Maintenance	14
3.3.1 Maintenance Schedule	14
4 Introduction	15
4.1 Definitions, Acronyms, and Abbreviations	16
4.2 System Structure with EMIS4	18
4.3 Data Transmission	19
4.3.1 Data Flow	19
4.4 EMIS4 Interface	20
4.5 EMIS4 Connections	22
5 FTL and FAS	23
6 LED Status Information	24
7 DIP switch	28

8	SIM Card	29
8.1	Inserting the SIM Card	29
9	System Information – FAS/ADMIN	30
10	NoMix Information – FAS/QAS	32
11	MultiLevel Information – FAS/LEVEL	33
12	MultiFlow Information – FAS/METER	34
12.1	FAS/METER/SETUP	34
12.1.1	FAS/METER/SETUP/ONr_L1124	35
13	MFSI Information – FAS/METERSI	36
14	GPS	37
15	Data Transmission	40
15.1	GSM/GPRS/4G	40
15.1.1	Basic GSM Settings	40
15.1.2	Advanced GSM Settings	42
15.1.3	Basic GPRS/4G Settings	43
15.1.4	Wireless Module Status	44
15.2	FTP Server	45
15.2.1	DATA	45
15.2.2	SERVICE	47
16	CAN Bus Status	48
17	Update	49
17.1	Update via USB Stick	49
17.2	Update via FTP download	50
18	Monitoring – Sensor Monitoring	51
18.1	General Information	51
18.2	MultiFlow Monitoring	52
18.2.1	Configuration	52
18.3	EMIS4 Monitoring	53
18.3.1	Configuration Sensor-Interface	54
18.3.1.1	General Settings	54
18.3.1.2	Sensor Configuration	55

18.3.1.3	Interface Information	56
18.3.1.4	Interface Status	57
18.3.1.5	Current Status	58
18.3.1.6	Offline Events	58
18.3.1.7	Snapshot	59
18.3.2	Configuration Wetleg-Interface	59
18.3.2.1	General Settings.....	59
18.3.2.2	Sensor Configuration	60
18.3.2.3	Interface Information	61
18.3.2.4	Interface Status	62
18.3.2.5	Current Status	63
18.3.2.6	Snapshot	65
18.4	Event File Transfer.....	66
18.5	EMIS4 example configuration	68
18.5.1	MultiFlow-Monitoring	68
18.5.2	EMIS4-Monitoring	68
19	Windows Tools _____	72
19.1	EMIS-Organizer	72
19.2	EMIS4-Configurator	73
20	Abbreviations _____	75
20.1	Storage Classes	75
20.2	Data Types.....	75
20.3	Error Codes	76
21	Technical Specifications _____	77
22	Address and Contact _____	78
Appendix A Antenna Assembly _____		79
Index _____		83
23	Drawings _____	84
	P8000008262 – EMIS4 interface, complete – EMIS4.....	84
	P8000008261 – EMIS4 connections	85
	P8000008083 – GPS4 receiver/receiver – GPS4	86
	P8000009956 – USB service cable – EMIS4/MultiTask	87
	P8000020827_01 – Monitoring Standalone.....	88
	P8000020827_02 – Monitoring Standalone.....	89
	P8000020828_01 – Monitoring MultiFlow A1	90

P8000020828_02 – Monitoring MultiFlow A1	91
P8000020829_01 – Monitoring MultiFlow A3	92
P8000020829_02 – Monitoring MultiFlow A3	93
P8000020830_01 – Monitoring MultiTask.....	94
P8000020830_02 – Monitoring MultiTask.....	95
24 Approvals	96
EU Declaration of Conformity - MultiTask / EMIS4	96
EU Declaration of Conformity - MultiFlow	98
EU Declaration of Conformity - pressure switches.....	99
EU Declaration of Conformity – Monitoring sensor INS1... ..	100
EU Declaration of Conformity – wetleg sensor NS-2	101
EU Declaration of Conformity – Wetleg interface.....	102
EU Declaration of Conformity - SPD-Interface	103
EU Declaration of Conformity - RFID	104

1 List of References

- [1] DIN, EN 15969-1-2018 FTL-Protokoll, 2018.
- [2] TechnipFMC, TMC Application Telegrams, DOK-279.
- [3] TechnipFMC, FAS CAN-Bus Protocol FPI-Ext, 2020.
- [4] TechnipFMC, Elektronischer Tankwagenrechner MultiFlow Dok-383.
- [5] TechnipFMC, SPD-Namursensor Interface MSSPD-N - DOK-570.
- [6] TechnipFMC, Restmengensensor-Interface NM2-WET - DOK-568.
- [7] TechnipFMC, DOK-558_EMIS Communications_MNF19002EN-R302.

2 General Information

2.1 Orientation Aids for the Manual

In order to make it easier to find the information that you are looking for in this manual, we have created a number of orientation aids.

The information in this manual ranges from mandatory protective measures and standardized specifications to concrete action steps and suggestions. To ensure better distinction in the context, this information is marked by corresponding pictograms in front of the text

These are not only intended to raise the attention of the reader but should also help with finding the desired information more quickly. Consequently, the pictograms are representative of the text content that follows.

The following pictograms are used in this manual:



Danger-notice

Risk of explosion due to highly flammable gases and liquids.



Risk of operational malfunction

Actions that damage the device.



Legal notice

Actions that have legal consequences.



Work step

Action required, e.g., “Press the <Enter> button”.



Input required

e.g., via numeric or function buttons.



Feedback positive

e.g., “The main menu now appears”.



Feedback negative

e.g., “In the event that an error message now appears...”.



Background-information

Quick tip, e.g., “Further information is available in Section XX”.



Option

Special case.



Function

Function description.



NOTE:

Indicates a special **situation**.



ATTENTION:

For special attention.

2.2 Safety Information



Attention:

Please read carefully and observe before commissioning.

2.2.1 Please Note



The system contains precise, high-quality components. Consequently, mechanical effects not because of operation (e.g., falls) must be avoided.



ATTENTION:

Do not open the housing cover while the system is live!

Work on the Ex-e terminals may only be carried out when powered off. When commissioning, national regulations must be observed. When carrying out functional checks, the guidelines in accordance with IEC/EN 60 079-17 must be observed.

2.2.2 Disposal



Verify all applicable regulations with the appropriate local authorities. Ensure that the respective substances are disposed of in an environmentally responsible manner.



The operating company is responsible for ensuring that the generally applicable and local regulations in effect at the time of disposal are complied with.

2.2.2.1 Disposal of the Function Group or System

- Once the function group or system has been taken out of service, we recommend its disposal by type. Separate ferrous metals, non-ferrous metals, plastics, electronic scrap, etc.
- Plastics, greases, oils, and objects and cables contaminated with these products must be disposed of separately.

2.2.3 Intended Use



The system is an interface that transmits the data generated by the Sening Systems installed on tankers: (NoMix, MultiSeal, MultiLevel,

MultiFlow, etc.) to an FTP server. The corresponding safety regulations (e.g., explosion protection) must be observed and complied with.

- ☐ Any other use is considered misuse. F.A. Sening GmbH cannot be held liable for any damage resulting from misuse.
- ☐ Intended use also includes the operating, installation, and maintenance conditions specified by F.A. Sening.
- ☐ The system may only be installed, operated, maintained, and repaired by people who are familiar with the system and have been informed of its hazards.
- ☐ Please contact our service team if you observe faults or defects during operation or have any doubts about proper operation of the devices.
- ☐ Unauthorized modifications to the device exclude all liability of F.A. Sening GmbH for resulting damage.

3 General Installation Information

§ **Installation of the device or system on road tankers may only be carried out by specialist companies.**

☞ This specialist company must set up and test the overall system in accordance with the test criteria listed in the operating instructions. Proper setup of the system must be certified.

☞ In addition to the items listed below, all applicable regulations, such as IEC/EN 60079-14, must be observed during setup, operation, and maintenance. Only if these instructions are taken into account can we guarantee prolonged and fault-free operation.

3.1 Precautionary Measures

3.1.1 For Preventing Accidents (Due to Potential Gas Ignition)



Observe explosion protection regulations!

If cable glands in AI terminal boxes need to be replaced, only Ex-approved cable glands may be used.



All assemblies are explosion-proof, electrical equipment, tested for safety, and certified. Instructions on Ex signs must be observed. In the event of a fault, the assembly concerned must be replaced in its entirety.

3.1.2 To Ensure Compliance with Standards



▶ Wiring must be carried out in accordance with the supplied wiring diagrams. The colors of the wires are governed by DIN 47100.

Always observe the color selection!

▶ Electrical installation must be carried out in accordance with IEC/EN 60079-14.

- ▶ The addition of additional components into the housing or into terminal boxes (e.g., additional terminals) is not permitted as this will void the device's approval.
- ▶ The manufacturer's EMC Declaration of Conformity is only valid if the system is installed exactly in accordance with the specifications (operating instructions and instructions) provided by the manufacturer.

3.1.3 To Ensure Fault-Free Operation

- ▶ Disconnect the power supply when undertaking welding work on the vehicle.
 - ▶ Always fit cable entries pointing towards the side or downward to ensure that water cannot penetrate into the housing.
 - ▶ Use blank caps to seal unused cable glands on the device(s) to ensure that they are watertight.
 - ▶ Protect terminal boxes and electronics cabinets as well as connectors from direct water flushed (e.g., from the tires).
 - ▶ Route all cables such that they cannot become damaged or kinked.
 - ▶ Use the blank plugs supplied on the **AI** terminal boxes.
 - ▶ Fit all wires with wire-end ferrules.
 - ▶ All electrical connections are established with screw terminals . Cables must be routed into the housing through the designated cable glands according to their diameter.
 - ▶ During assembly, a reliable and standardized electrical connection must be established between each metal housing and the vehicle chassis. Corrosion-resistant screws (V2A) with additional lock washers must be used.
-  When cutting the wires, ensure that no cable residue falls into the opened device. This can cause short-circuits on the circuit board.
-  Never establish a connection between the housing/screen and the 0 V strip. Doing this may cause malfunctions.

3.1.4 To Make Work Easier for the Service Team

- Terminal boxes should be installed in accessible locations.
- The electronics housings should always be installed in accessible locations.
- Cables without connectors may be shortened.

- Grease the fastening screws on the lids slightly before tightening them, e.g., with copper paste, graphite grease, etc.

3.2 Cable Routing in the Vehicle

The device or system has been designed for use on a vehicle.

✂ To ensure fault-free operation, the guidelines outlined in the previous sections must be followed during installation. Failure to follow these guidelines may cause malfunctions during operation.

§ In the event of demonstrable non-compliance with the guidelines or improper installation (breach of applicable regulations), we will assume no warranty in the event of malfunctions and resulting further claims.



All cables used must be resistant to fuel. Ex cables must be used for wiring in non-intrinsically safe areas.



All cables must be routed (protected) such that they do not become damaged during operation (operator working methods).

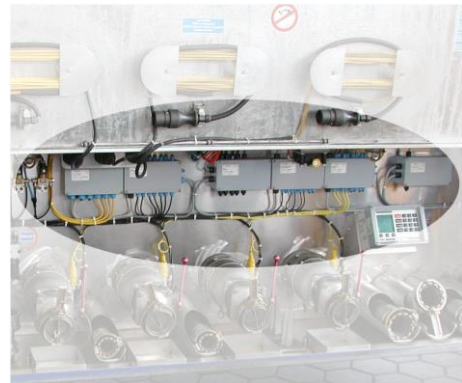

Example installation in tanker



Route a separate supply cable as a power supply.



Use a cable with a $\geq 1.5 \text{ mm}^2$ diameter.



The cable does not need to have a screen.



Take the +24 V voltage directly from the positive terminal of the battery via a fused cable.



Fuse the system with 8 A.



Take the 0 V cable as close as possible to the ground terminal of the battery.



If the system is switched off with a switch, the switch must be in the +24 V supply line.



The 0 V cable must not be switched.



Do not connect the printer to an additional power supply.



RISK OF EXPLOSION
Any intervention – mechanical or electrical – is prohibited

3.3 Maintenance

Mechanical or electronic modifications to the devices themselves are not permitted.



In the event of cleaning work with a steam jet or pressurized water, the devices must be protected from the water jet. Never hold the steam jet directly at the devices.



In the event of moisture in the devices that can be attributed to improper cleaning, warranty claims will be refused.



A regular safety inspection of all devices must be carried out at regular intervals in accordance with the Ordinance on Industrial Safety and Health. Devices and protective systems that are covered by Directive 94/9/EC and are operated in areas at risk of explosion are systems that require monitoring. The international standard EN 60079-17 and other country-specific directives must be observed.

3.3.1 Maintenance Schedule

	Daily	Weekly	Monthly	Annual
Clean the exterior of the device			X	
Visual inspection	X			
Check the LEDS				X
Check the housing fastening for firm seating		X		
Check the cables		X		

4 Introduction

- ☐ The **E**uropean **M**ultiple **I**nterface **S**ystem 4 for tankers (EMIS4) is a replacement for the existing EMIS3 device (not for EMIS2) and the communications device for future Gen-X tanker developments.
- ☐ The EMIS4 acts as an interface between the components in the Sening vehicle system.
 - ▶ QAS node → NoMix, MultiSeal, and
 - ▶ METER node → MultiFlow
 - ▶ and future Sening® components.
- ☐ This information, such as transaction data or system events, can be transmitted to the control center and processed within it. Corresponding evaluation allows a traceable course of a trip to be reconstructed, both the complete production information and decisive activities in the vehicle.
- ☐ The EMIS4 is based on an embedded Linux operating system. The connection to the existing “Main Truck System” (MTS) NoMix/MultiSeal, MultiFlow, MultiLevel, etc. is achieved by a CAN bus.
- ☐ QAS events can be transmitted to an FTP server by GPRS/4G. Consequently, NO on-board computer (OBC) is required for evaluation of the QAS events.
- ☐ Communication with the EMIS4 is achieved with:
 - ▶ GSM/GPRS/4G (for the long section)
 - ▶ GPS (for satellite navigation)
 - ▶ Bluetooth (BT) (for short range, class 1)
 - ▶ A serial interface that is used as the service serial interface.
 - ▶ A second serial interface is used for connection of the GPS module.
 - ▶ An Ethernet port is provided for service purposes.
 - ▶ A USB connection on the processor board is provided for service purposes.
- ☐ The EMIS4 does not have a display or buttons.
- ☐ The EMIS4 is not intended for handling calibrated measured values or W&M values.
- ☐ It is approved for tankers in Ex zone 1.

4.1 Definitions, Acronyms, and Abbreviations

CAN	C ontroller A rea N etwork General packet-oriented wireless service.
FTL	F uel T ruck L ink The name for European standard DIN EN 15969. Tankers for the transportation of hazardous goods – digital interface for the exchange of data between tankers. This standard describes communication between the on-board computer and truck vehicle equipment. It also describes truck–FTP server communication. Section 1 handles logistics data and section 2 business data.
FTP	F ile T ransfer P rotocol A specific network protocol for the transmission of files via IP networks.
GPRS	G eneral P acket R adio S ervice The name for the packet-oriented service for data transmission in GSM networks
GSM	G lobal S ystem for M obile Communications A standard for fully digital mobile communications networks used chiefly for telephony, but also for circuit-switched and packet-switched data transmission and short messages.
OBC	O n- B oard C omputer A small computer installed in tankers.
MISRA	M otor I ndustry S oftware R eliability A ssociation A C programming standard from the automotive industry that was developed by MISRA.
NMEA	N ational M arine E lectronics A ssociation 0183 A US association of electronics manufacturers and dealers in the marine industry. The association was founded in 1957 and registered as a company in 1969. Its principal objectives are the promotion of standards and technical developments in marine electronics, as well as the technical education of its members.
QAS	Q uality A ssurance S ystem A company-independent marking for a quality assurance system on tankers. At F.A. Sening, these are the NoMix and MultiSeal systems.
RMC	R ecommended M inimum sentence C , The NMEA data set, type RMC , is the most common data set transmitted by GPS devices. The NMEA data set contains everything that a GPS program requires: length,

width, speed, direction, time derived by satellite, fix status, and magnetic deviation.

RTC **Real Time Clock**

EMIS4 **European Multiple Interface System**

Wireless module for tankers – the project name for a new device developed by F.A. Sterling that is a replacement for the EMIS3.

TDL **Truck Data Link**

The name for the German standard DIN 26051-x. This name describes the data interface for tankers for business data (section 1) and for logistics data (section 2). It was published in the year 2000 and is a form of precursor to FTL.

TVE **Truck Vehicle Equipment**

Tanker equipment

4.2 System Structure with EMIS4

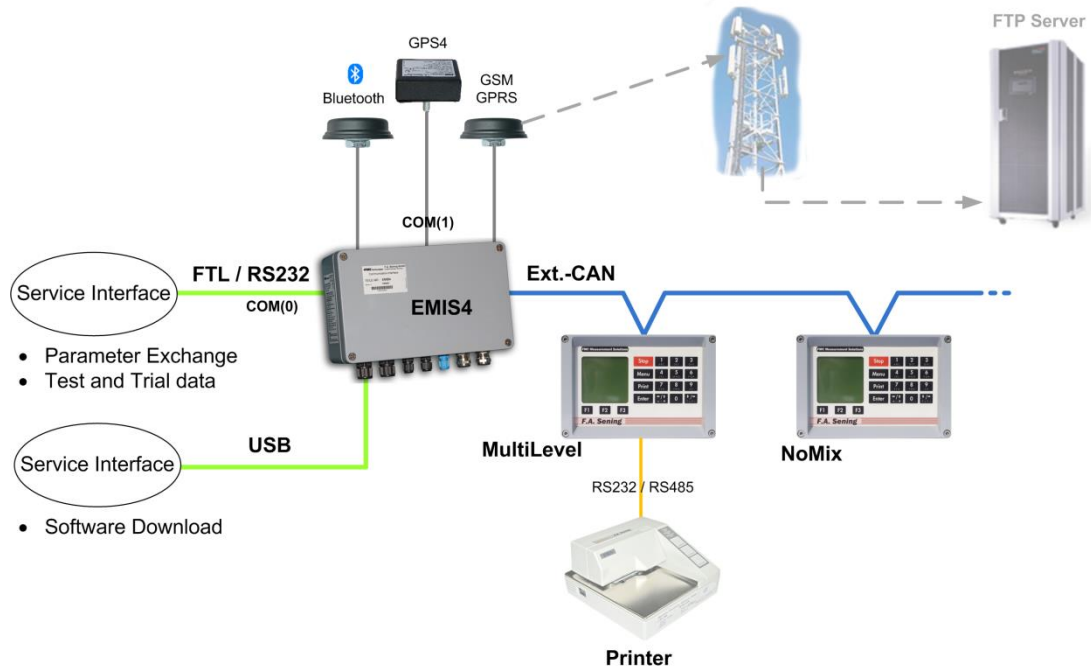

Fig. 1: Key parts of the system and the modules

4.3 Data Transmission

- ☐ The EMIS4 provides a series of variables (nodes) in an FTL tree structure, via which data can be exchanged with the connected devices.
- ☐ Nodes that are not supported by the FTL standard are available in a separate FAS tree structure.

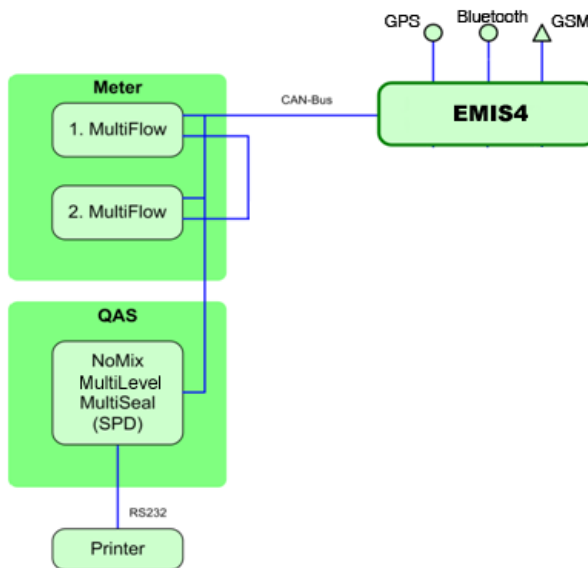

Fig. 2: Data Transmission

4.3.1 Data Flow

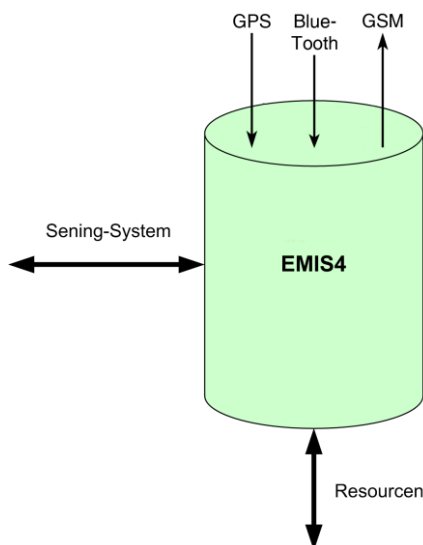

Fig. 3: EMIS4 data flow

- ☐ Retrieval of status information of the individual devices

4.4 EMIS4 Interface

Part no.: **EMIS4**

Drawing: P8000008262 / p. 84

Connection diagram:

P8000008261/85

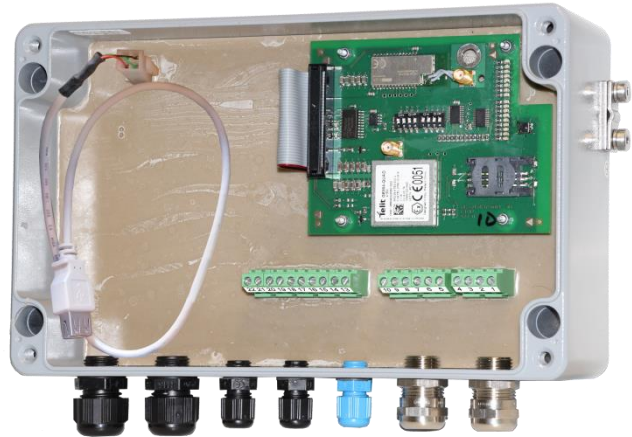

Figure 4: EMIS4 Interface

- ☐ The EMIS4 electronics mainly comprise 2 modules: one main board with 20 terminals for the external connections and the communication modules outside of the housing. Both parts are secured to a base plate with 4 bolts in the lower section of the housing.
- ☐ The EMIS4 interface (part no. **EMIS4**) consists of the **Global Main CPU board** with the power supply board with power supply, interface drivers, terminals, and of the **FMC Global Stick module** with microprocessor, program memory, SD card interface, and power management (WatchDog). Both modules are cast in the housing.
- ☐ There is a clock module on the **Global Main CPU board**. When the EMIS4 is switched off, this module and the data memory, in which data that accrue during operation are stored, are powered by the lithium battery on the power supply board.
- ☐ In the case of a fully charged battery, a typical “power reserve” of 6 months should be expected (under unfavorable conditions, this is reduced to 4 weeks).
- ☐ The program is located in the Flash EEPROM and does not need to be supplied with power when switched off.
- ☐ The EMIS4 interface has the following connections:
 - 24 V/DC power supply (max. 500 mA)
 - COM_1 serial RS232 interface for service purposes
 - COM_2 serial RS485/RS232 interface for OBC (FTL)
 - F.A. Sening ext. CAN bus for connection to other Sening components

- Bluetooth antenna (optional)
- GPS receiver
- GSM antenna
- SIM card holder for the SIM card
- USB service cable for the service interface (software download)
(see drawing: **P8000009956**/page 87)

4.5 EMIS4 Connections

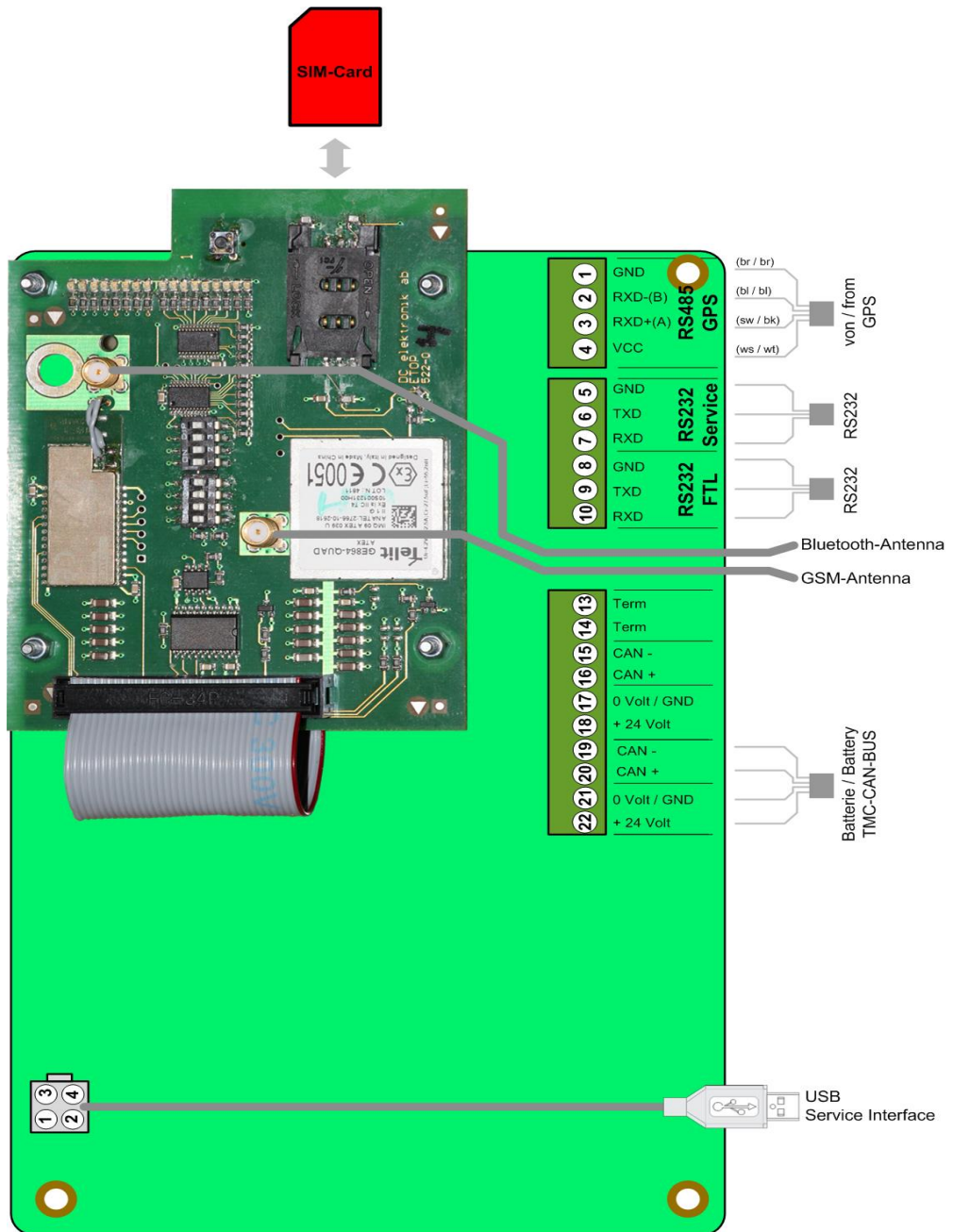

Fig. 5: EMIS4 connections (drawing: P800007800)



NOTE:

A non-terminated CAN bus may cause (temporary) problems with communication on the CAN bus. The CAN bus must be created as a bus. If the EMIS4 is located at the end of the CAN bus, it must be ensured that the CAN bus is terminated in the EMIS4. This is achieved with a bridge between the two “term” connections.

5 FTL and FAS

- ☐ Communication with the EMIS4 is based on the FTL standard [1].
- ☐ When the OBC communicates with the EMIS4, the specifications of the FTL protocol must be observed, as specified in the FTL standard.
- ☐ All data that are transmitted from the EMIS4 to the DATA FTP server are based on the FTL format specified in the FTL standard.
 - This does not affect the log files!
- ☐ As the EMIS4 is only intended for the transmission of data from the respective tanker system to the FTP server, a small number of the nodes intended by the FTP standard are supported.
 - Access to the data via the FTL node tree outlined in the standard.
 - List of all supported nodes possible via “NodeList” query.
- ☐ As not all functions and interfaces supported by the FTL standard are taken into consideration by the FTL standard, these can be accessed via a separate FAS node tree. The general specifications of the FTL protocol must also be taken into account for access to the FAS node parameters.
 - Access to the data not supported by the FTL standard via the separately available FAS node tree.

6 LED Status Information

- Information about the respective statuses of individual functions of the EMIS4 can be obtained from the differently colored LEDs on the communications board.



The individual LEDs have the following functional assignment:

- L

communications board

Fig. 6: Communications board with SIM card

- LED 1 (green) : Power supply voltage
- LED 2 (green) : Status
- LED 3 (red) : Not used
- LED 4 (yellow) : FTL
- LED 5 (yellow) : GPS
- LED 6 (yellow) : CAN
- LED 7 (red) : Bluetooth
- LED 8 (red) : Bluetooth
- LED 9 (green) : USB
- LED 10 (green) : GSM
- LED 11 (yellow) : GPRS
- LED 12 (yellow) : Not used
- LED 13 (green) : Not used
- LED 14 (green) : Not used
- LED 15 (yellow) : Not used
- LED 16 (yellow) : Not used

- LED 17 (red) : Not used

 The statuses of the individual functions are indicated by different LED flashing patterns.

- LED OFF:
 - **LED OFF**
 - Interface is inactive
 - (Deactivated, not available, requisite hardware not available, etc.)
- LED flashing at 2 Hz:
 - **LED 2 Hz**
 - Interface correctly initialized; basic function available
- LED flashing at 4 Hz:
 - **LED 4 Hz**
 - Next level after 2 Hz flashing
 - Advanced function available or other status
- LED ON:
 - **LED ON**
 - Connection established, ready for further data traffic
- LED ON with short OFF breaks:
 - **LED ON OFF breaks**
 - Data are being transmitted correctly according to the respective protocol.

LED	Function	Controlled via	Color	Status	Meaning
L1	Power supply	Hardware	Green	LED ON	Hardware power ON
				LED OFF	Hardware power OFF
L2	Status EMIS4	Application	Green	LED ON	Application without problems
				LED 2 Hz	General error in the application
L3	Service mode	Application	Red	LED ON	Service mode ON
				LED OFF	Service mode OFF
			Yellow	LED ON	COM(0) is active

LED	Function	Controlled via	Color	Status	Meaning
L4	Status of FTL interface (OBC)	Application	Yellow	LED ON OFF breaks	Receiving valid FTL request frame(s)
L5	GPS status	Application	Yellow	LED OFF	GPS: No GPS receiver connected
				LED 2 Hz	GPS: No satellites visible
				LED 4 Hz	GPS: Sufficient for 2D data
				LED ON	GPS: Sufficient for 3D data
L6	Receipt on CAN bus	Application	Yellow	LED OFF	CAN socket open failed
				LED 2 Hz	The CAN process is waiting for an OPEN or ACK_OPEN telegram
				LED ON	The CAN process has received a first valid OPEN or ACK_OPEN telegram
				LED ON OFF breaks	Valid "TMC application" telegrams received
				LED 4 Hz	CAN socket in error status (error active, error passive, bus off)
L7	Bluetooth (BT) status or Communication , filling platform or FTP	Application	Red	LED OFF	BT process not started
				LED 2 Hz	BT-SPP or BT-FTP waiting for connection
				LED 4 Hz	BT-SPP or BT-FTP connected, but no data transmission
				LED ON	BT-SPP or BT-FTP connected, and first data sent/received
				LED ON OFF breaks	Active data transmission
				LED OFF	Update via Bluetooth

LED	Function	Controlled via	Color	Status	Meaning
L8	Bluetooth software update (FTP)	Application	Red		deactivated (D6 = OFF)
				LED ON	Update via Bluetooth activated (D6 = ON)
				LED ON OFF breaks	Bluetooth FTP software update active
L9		Application	Green	LED OFF	Reserved
L10	GSM network available	Application	Green	LED OFF	GSM network not available
				LED ON	GSM network available
L11	GPRS connected + online + FTP data transmission	Application	Yellow	LED OFF	GPRS not connected
				LED 4 Hz	GPRS connected but not online
				LED ON	GPRS online
				LED ON OFF breaks	FTP data transmission active
L12		Application	Yellow	LED OFF	Reserved
L13		Application	Green	LED OFF	
L14		Application	Green	LED OFF	
L15		Application	Yellow	LED OFF	
L16		Application	Yellow	LED OFF	
L17	USB update	Application	Red	LED OFF	
				LED ON	Update file transmission

7 DIP switch

- ☐ There are 8 DIP switches in the EMIS4, on the communications board, which have been assigned different functions:

DIP switch	Function	Setting
1	UART0/service RS232 enable	OFF
2	Boot sequence	ON
3	Boot sequence	ON
4	TMC node 2 ⁰	ON
5	TMC node 2 ¹	OFF
6	TMC node 2 ²	ON
7	TMC node 2 ³	ON
8	TMC node 2 ⁴	OFF

- ☐ DIP switches 1 - 3 are used to define basic system properties. The specified basic settings may only be modified following consultation with TechnipFMC.
- ☐ DIP switches 4 - 8 are used to set the node number of the EMIS4 on the TMC-CAN bus. The TMC-CAN bus is used for communication with Sening systems, such as MultiFlow, MultiLevel, MultiSeal, and NoMix.
- ☐ Node numbers 0 - 31 are possible on the TMC-CAN bus. The default node number for EMIS2 and EMIS4 is 21.
- For the EMIS to be able to communicate with other systems via the TMC-CAN bus, the node number of the EMIS must also be set in the setup of the other systems on the TMC-CAN bus.
 - If DIP 4 - 8 are set to OFF, node number 21 is used automatically.
- ☐ This setting is ignored in EMIS4 monitoring, as the EMIS4 communicates with the FAS protocol in this function.



NOTE:

The correct setting must be ensured, particularly with DIP switches 1, 2, and 3. These DIP switches have, in part, a direct influence on the starting behavior of the system. Erroneous settings can cause starting problems for the system.

8 SIM Card

☐ If the GSM/GPRS function is to be used with the EMIS4, the device must be equipped with a standard SIM card. It must be ensured that the SIM card holder with the card is correctly inserted into the card holder slot.

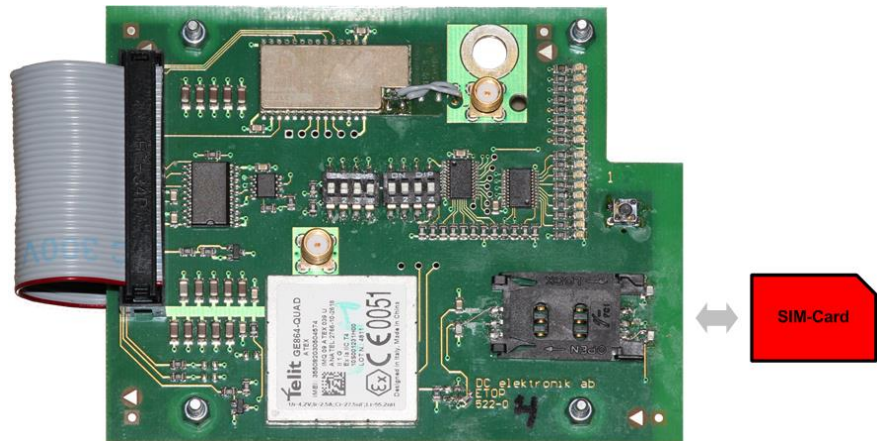
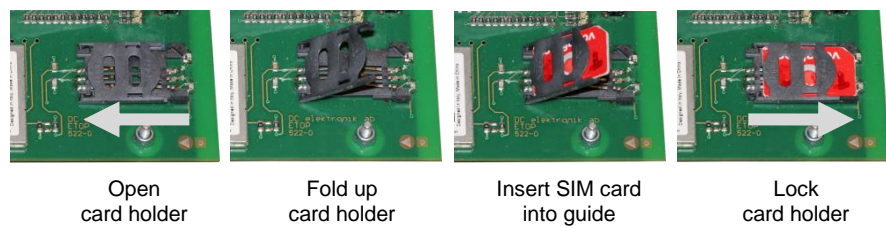

Fig. 8: Communications board with SIM card

8.1 Inserting the SIM Card

☞ SIM card holder for SIM cards



☐ Use of the SIM card requires a contract with a telecommunications provider. As data transmission from the EMIS4 takes place via the internet using the GPRS service, these functions (GPRS data transmission and Internet access) must be included as services under the contract. No voice transmission is required. For cost reasons, billing must be based on the quantity of data transmitted and not on the connection time. Availability over the widest possible area is important.

9 System Information – FAS/ADMIN

 Detailed information on the system status can be determined using different parameters of the FAS node tree.

Nodes: FAS/ADMIN/DEVICE

Name	Description	Storage	Data Type	Access	Data Type	Add. Info.
Serial	Serial number	NV	CI	RD		EMIS4 serial number
Name	Designation	NV	CI	RD		Device designation
HWVersion	Hardware version	NV	CI	RD		-
SWVersion	Software version	NV	CI	RD		-
Node	TMC-CAN node	NV	CI	RD		Internal CAN node for communication via TMC-CAN protocol

Nodes: FAS/ADMIN/STATUS

Name	Description	Storage	Data Type	Access	Data Type	Add. Info.
LastError	Last system error	VO	CI	RD	C50	Set according to the last error status of the system; Reset after being read
Mode	Current EMIS4 status	VO	CI	RD	N1	
Reset	System reset	NV	OT	WR	C15	Executes an EMIS4 reset.

Nodes: FAS/ADMIN/VEHICLE

Name	Description	Storage	Data Type	Access	Data Type	Add. Info.
Name	Vehicle designation	NV	PA	RD/WR	C15	Specifies the vehicle designation required in the FTL standard

Nodes: FAS/ADMIN/CLOCK

Name	Description	Storage	Data Type	Access	Data Type	Add. Info.
Date	Date	VO	CI	RD/WR	<CCYYMMDD>	Current date
Time	Time	VO	CI	RD/WR	<hhmmss>	Current time
AutoDST	Automatic daylight-saving time changeover	NV	PA	RD/WR	B	Automatic summertime <-> wintertime changeover 0: No 1: Yes
CurrentDST	Current summer/wintertime status	VO	CI	RD		

10 NoMix Information – FAS/QAS

- ☐ For more detailed information on EMIS4 operation in combination with NoMix2000 and/or MultiSeal, please contact the service department at TechnipFMC directly.

11 MultiLevel Information – FAS/LEVEL

 For more detailed information on EMIS4 operation in combination with MultiLevel, please contact the service department at TechnipFMC directly.

12 MultiFlow Information – FAS/METER

 For more detailed information on EMIS4 operation in combination with MultiFlow, please contact the service department at TechnipFMC directly.

12.1 FAS/METER/SETUP

Nodes: FAS/METER/SETUP

Name	Description	Storage	Data Type	Access	Data Type	Add. Info.
MeterCount	Number of MultiFlow(s)	VO	CI	RD	N1	Number of detected MultiFlow systems
EventStyle	Filter MultiFlow-events	NV	PA	RD/WR	C11	Type of logbook data, requested from MultiFlow “ALL”: complete “DELIVERY”: Only delivery data “IO”: Only IO-Interface related events
ONr_L1124	Definition Handling L1124	NV	PA	RD/WR	N1	‘0’: L1124 in MTR-File = Customer-Nr. ‘1’: L1124 in MTR-File = Order-Nr. Default: ,0‘

12.1.1 FAS/METER/SETUP/ONr_L1124

Entering the customer and/or order number in the MultiFlow delivery preselection is optional. By default, both queries are deactivated and can be activated separately depending on customer requirements. The customer number can consist of up to 8 numbers, the order number of up to 10 numbers and letters.

The FTL-Standard is not supporting transmitting the customer- and the order-number at the same time within FTL record 11.

- ☐ The system operator can use the node "*FAS,METER,SETUP,ONr_L1124*" to specify, which information, received from the MultiFlow, should be transferred from the EMIS4 together with the delivery information in FTL record 11 "*Transfer*" of the MTR file to the FTP server.

13 MFSI Information – FAS/METERSI

 The “METERSI” node is used to query the device information of an optional MFSI sensor interface in the system.

Nodes: FAS/METERSI/DEVICE

Name	Description	Storage	Data Type	Access	Data Type	Add. Info.
Serial	Serial number	VO	CI	RD		MFSI serial number
Name	Designation	VO	CI	RD		MFSI designation
HWVersion	Hardware version	VO	CI	RD		Hardware version of the MFSI
SWVersion	Software version	VO	CI	RD		Software version of the MFSI
Node	CAN node	VO	CI	RD		Unique CAD node number in the TMC-CAN bus of the MFSI

14 GPS

 An optional GPS receiver may be connected to the EMIS4. The GPS information is for the acquisition of position data as well as for system time synchronization.

Nodes: FAS/GPS/DEVICE

Name	Description	Storage	Data Type	Access	Data Type	Add. Info.
Name	Designation	VO	CI	RD		GPS receiver designation
SWVersion	Software version	VO	CI	RD		Software version of the GPS receiver

Nodes: FAS/GPS/STATUS

Name	Description	Storage	Data Type	Access	Data Type	Add. Info.
LastError	Last error status	VO	CI	RD		The last error status can be retrieved. The status is automatically reset after the query.
Mode	Wireless module mode	VO	CI	RD		Information on the current status of the GPS receiver

Nodes: FAS/GPS/SETUP

Name	Description	Storage	Data Type	Access	Data Type	Add. Info.
TimeSync	Time	NV	PA	RD/WR	N1	Synchronization of the system

Name	Description	Storage	Data Type	Access	Data Type	Add. Info.
	synchronization					time with the time information received via GPS.
UTCOffset	UTC offset	NV	PA	RD/WR	C7	The offset to UTC to be taken into consideration when adopting the time.
FTL_File	GPS file transmission	NV	PA	RD/WR	N1	0: No GPS file will be sent 1: GPS file will be continuously sent and updated.

 The data currently being transmitted via the GPS receiver can be queried via the following node of the FAS tree

- Nodes: FAS/GPS/DATA
- Nodes: FAS/GPS/SUBDATA

 The data last received via the GPS receiver and transmitted by the EMIS4 can be queried via the following node of the FAS tree

- Nodes: FAS/GPS/LASTDATA
- Nodes: FAS/GPS/LASTSUBDATA

 When the GPS receiver is connected, tracking information can be transmitted from the EMIS4 to the DATA FTP server. The tracking behavior is defined in a separate GPS subnode.

Nodes: FAS/GPS/TRACKING

Name	Description	Storage	Data Type	Access	Data Type	Add. Info.
Status	Tracking status	VO	CI	RD		Current tracking mode
Format	Format information	VO	CI	RD		Tracking data format information
Interval	Tracking	NV	PA	RD/WR	N4	Tracking data interval in [s]

Name	Description	Storage	Data Type	Access	Data Type	Add. Info.
	interval					
Distance	Tracking distance	NV	PA	RD/WR	N6	Distance deviation from which the tracking data must be determined in [m]
Speedlevel	Tracking speed threshold	NV	PA	RD/WR	N3	Speed from which the tracking data must be determined in [km/h]

15 Data Transmission

- ☐ The principal task of the EMIS4 is to transmit system data (submissions, sensor changes, etc.) in FTL format to the configured FTP server.
- ☐ Data transmission is via the integrated GSM/GPRS/4G module.

15.1 GSM/GPRS/4G

15.1.1 Basic GSM Settings

- ☐ For the GSM/GPRS/4G module to be able to connect to the network of the respective network provider and to transmit data, a number of basic settings must be implemented. These basic parameters are outlined below.
- ☐ The EMIS4 supports SIM cards with and without pin. SIM cards without PIN are detected automatically. Any PIN specified in this case is ignored.

Nodes: FAS/GSM/DEVICE

Name	Description	Storage	Data Type	Access	Data Type	Add. Info.
PIN	SIM card PIN	NV	PA	RD/WR	N8	-
TimeOut	GSM timeout	NV	PA	RD/WR	N3	Inactivity timeout for termination of the GPRS connection after data transmission
PhoneNo	Data call number	NV	PA	RD/WR	N16	-
MNO	Mobile Network Operator	NV	PA	RD/WR	N3	Corresponds to the provider specifications of the "Mobile Network Operator". Default: "100"
Serial	Serial number	VO	CI	RD		Wireless module serial number

Name	Description	Storage	Data Type	Access	Data Type	Add. Info.
Name	Designation	VO	CI	RD		Wireless module designation
SWVersion	Software version	VO	CI	RD		Software version of the wireless module
IMSI	IMSI	VO	CI	RD		Unique identifier of the wireless module
Network	Network definition	NV	PA	RD/WR	N1	<p>Only valid for GSM-Module "SARA-R412"!</p> <p>Definition of the network to be used by the module and their priorities.</p> <p>0 : GPRS only</p> <p>1 : LTE Cat-M1, LTE Cat-NB1, GPRS</p> <p>2 : LTE-Cat NB1, LTE Cat-M1, GPRS</p>

 The "Mobile Network Operator" specification is only required for EMIS4, equipped with 4G IoT modules. This depends on the respective area of application and the network providers available in that area. Valid settings are:

Parameter	Type	Description
<MNO>	Number	<p>Mobile Network Operator (MNO) profile:</p> <ul style="list-style-type: none"> • 0: undefined / regulatory. For more details, see Notes. • 1: SIM ICCID/IMSI select • 2: AT&T • 3: Verizon • 4: Telstra • 5: T-Mobile US • 6: China Telecom • 8: Sprint • 19: Vodafone • 20: NTT DoCoMo • 21: Telus • 28: SoftBank • 31: Deutsche Telekom • 32: US Cellular • 33: VIVO • 39: SKT • 44: Claro Brasil • 45: TIM Brasil • 46: Orange France • 90: global • 100: standard Europe • 101: standard Europe No-ePCO. The factory-programmed configuration of this profile is the same of the standard Europe profile (<MNO>=100), but the ePCO is disabled. • 102: standard JP (global) • 198: AT&T 2-4-12. The factory-programmed configuration of this profile is the same of the AT&T profile (<MNO>=2), but the LTE band 5 is disabled. • 201: OCF-PTCRB. This profile is meant only for conformance testing.

 The parameter “Network” is used to specify to the GSM module “SARA-R412” which radio network or in which priority GPRS, LTE CAT-M1 or LTE CAT-NB1 should be used.

Configurable are:

0 : GPRS only

- The module is only logging into the GPRS network

1 : LTE Cat-M1, LTE Cat-NB1, GPRS

- The module first tries to log into the LTE CAT-M1 network. If this is not possible, try LTE CAT-NB1 and then GPRS.

2 : LTE Cat-NB1, LTE Cat-M1, GPRS

- The module first tries to log into the LTE CAT-NB1 network. If this is not possible, try LTE CAT-M1 and then GPRS.

The “Network” definition is only valid when using a “SARA-R412” communication module. This setting is ignored for all other GSM modules.

15.1.2 Advanced GSM Settings

 The baud rate on the internal interface can be adjusted to the wireless module. This setting should only be changed for valid reasons.



NOTE:

The baud rate of the RS232 to the wireless module must not be changed while data transmission is active.

Nodes: FAS/GSM/SETUP

Name	Description	Storage	Data Type	Access	Data Type	Add. Info.
Baud	Baud rate	NV	PA	RD/WR	N6	Transmission speed on the internal RS232 to the wireless module Default: 115200

15.1.3 Basic GPRS/4G Settings

 Some settings (such as the APN, username, password) depend on the respective network provider. The correct settings are provided by the network provider (on request).

Nodes: FAS/GSM/GPRS

Name	Description	Storage	Data Type	Access	Data Type	Add. Info.
UserName	Username	NV	PA	RD/WR	C20	According to the network provider's specification Default: "user"
Password	Password	NV	PA	RD/WR	C20	According to the network provider's specification Default: "user"
APN	Access Point Name	NV	PA	RD/WR	C50	According to the network provider's specification
DNS1	DNS-Server1	NV	PA	RD/WR	C15	According to the network provider's specification Default: blank
DNS2	DNS-Server2	NV	PA	RD/WR	C15	According to the network provider's specification Default: blank
TimeOut	GPRS timeout	NV	PA	RD/WR	N3	Timeout for connection to GPRS/4G

15.1.4 Wireless Module Status

- ☐ The current connection status of the module can be queried.
- ☐ Information about the current network quality can be determined.
- ☐ In the event that the field strength is too low (<10), there may be noticeable problems.

Nodes: FAS/GSM/STATUS

Name	Description	Storage	Data Type	Access	Data Type	Add. Info.
LastError	Last error status	VO	CI	RD		The last error status can be retrieved. The status is automatically reset after the query.
Mode	Wireless module mode	VO	CI	RD		Information on the current status of the wireless module. "REGISTERED": All OK or online
RSSI	Field strength	VO	CI	RD		Current field strength determined by the wireless module
BER	Bit error rate	VO	CI	RD		Current bit error rate determined by the wireless module

15.2 FTP Server

- ☐ 2 FTP servers can be configured in the EMIS4
 - “DATA”
 - FTP server to which event, MultiLevel, and MultiFlow data should be transmitted
 - FTP server to which GPS tracking data should be transmitted
 - FTP server to which the internal log files of the EMIS4 should be transmitted
 - “SERVICE”
 - FTP server for downloading update files
 - FTP server to which system information should be transmitted
- ☐ Customer-specific FTP servers can also be configured.
 - These only need to support passive FTP.
 - The folder structure on the FTP server must be created in accordance with the requirements of the EMIS4.

15.2.1 DATA

- ☐ The data determined by the EMIS4 are stored in different files in FTL format and transmitted to this FTP server.
- ☐ Separate event, MultiLevel and MultiFlow files, GPS files, and log files are transmitted, depending on the system configuration.
- ☐ A special folder structure is required on the server, to which the EMIS4 must be granted access for file saving and modification.
 - /Base folder
 - Event, MultiLevel, and MultiFlow files are saved here.
 - /Base folder/GPS
 - One uniquely identifiable GPS file is created here per day. The GPS tracking information is permanently added to this file.
 - /Base folder/Log
 - The EMIS4 generates internal log files that can provide information about the internal program workflows, depending on the configuration. More or less data are captured, depending on the set log level. If one of the log files reaches a certain size, it is transmitted to the FTP server and can be evaluated as necessary.

Example (FTP-Server already received MultiFlow files):

Name	Erw.	Größe	Datum	Attr.
[..]				
[GPS]			17.05.2023 10:31	----
[Log]			16.05.2023 15:23	----
MTR2d20230517092847	ftl	427	17.05.2023 10:29	----
MTR1d20230517091734	ftl	419	17.05.2023 10:27	----
MTR1d20230516072439	ftl	417	17.05.2023 10:26	----
MTR1d20230516072954	ftl	364	17.05.2023 10:26	----

Figure 9: Example FTP-Server directory structure

Nodes: FAS/GSM/GPRS/FTP/DATA

Name	Description	Storage	Data Type	Access	Data Type	Add. Info.
Domain	FTP server domain	NV	PA	RD/WR	C100	The URL via which the FTP server can be accessed
UserName	Username	NV	PA	RD/WR	C20	According to the FTP server specification
Password	Password	NV	PA	RD/WR	C20	According to the FTP server specification
Path	Path	NV	PA	RD/WR	C200	If the base folder is located in a subfolder, it must be specified here
ZIP	Compression	NV	PA	RD/WR	B	"0": Data are transmitted uncompressed "1": Data are compressed and transmitted in ZIP format
TimeOut	FTP timeout	NV	PA	RD/WR	N3	Timeout for establishing a connection to the FTP server
Test	Connection test	VO	OT	WR	C10	Initiates transmission of a test file to the FTP server. The name of the test file can be specified here.

15.2.2 SERVICE

- ☐ The EMIS4 software can be updated via USB and via download from the FTP server. The FTP server that must be used for downloading the update files must be specified here.
- ☐ Every time a GSM/GPRS connection is established, a small system-info-file is transferred to the service FTP server. The file is only a few bytes in size and is containing information concerning the system identification like name, serial number, version number and IP address.

Nodes: FAS/GSM/GPRS/FTP/SERVICE

Name	Description	Storage	Data Type	Access	Data Type	Add. Info.
Domain	FTP server domain	NV	PA	RD/WR	C100	The URL via which the FTP server can be accessed
UserName	Username	NV	PA	RD/WR	C20	According to the FTP server specification
Password	Password	NV	PA	RD/WR	C20	According to the FTP server specification
Path	Path	NV	PA	RD/WR	C200	If the base folder is located in a subfolder, it must be specified here
ZIP	Compression	NV	PA	RD/WR	B	"0": Data are transmitted uncompressed "1": Data are compressed and transmitted in ZIP format
TimeOut	FTP timeout	NV	PA	RD/WR	N3	Timeout for establishing a connection to the FTP server
Test	Connection test	VO	OT	WR	C10	Initiates transmission of a test file to the FTP server. The name of the test file can be specified here.

16 CAN Bus Status

- ☐ The EMIS4 supports 2 different CAN protocols. In normal operation, and with MultiFlow monitoring, the TMC protocol is [2] used. This is the standard protocol of the EMIS4 for communication on the CAN bus. The FAS protocol is used for EMIS4 monitoring [3].
- ☐ For the monitoring function in particular, it is useful to acquire information about the respective status of the communication on the CAN bus.
- ☐ The EMIS4 must be restarted each time the protocol is changed!

Nodes: FAS/CAN/Status

Name	Description	Storage	Data Type	Access	Data Type	Add. Info.
Protocol	CAN protocol used on the CAN(0)	VO	CI	RD	N1	0: TMC (default) 1: FAS
LastError	Last problem on the CAN(0)	VO	CI	RD	C50	Set according to the last error status of the interface. Reset after being read
Mode	Current interface status	VO	CI	RD	N1	0: Ready 1: Busy 2: ERROR



NOTE:

A not terminated CAN bus may cause (temporary) problems with communication on the CAN bus. The CAN bus must be created as a bus. If the EMIS4 is located at the end of the CAN bus, it must be ensured that the CAN bus is terminated in the EMIS4. This is achieved with a bridge between the two "term" connections.

17 Update

- ☐ The EMIS4 software can be updated both locally via the USB interface and via download from the service FTP server.

17.1 Update via USB Stick



Figure 10: EMIS4 Interface

- ☐ A special adapter cable is needed for the update via USB stick, which is connected to the rectangular 4-pin socket which protrudes from the housing. A standard USB stick can be connected to this cable.
- ☐ A specific folder structure is required on the USB stick for the update. When the EMIS4 detects a connected USB stick, it checks whether there is an update file with name “*rmtt_application.tar*” in the folder.

- Folder required:
 - <USB stick>:\service\update\rmtt

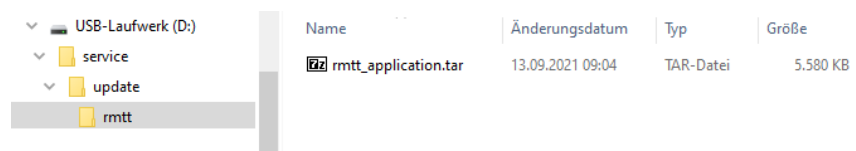

Figure 11: Example directory structure USB-Stick

- ☐ An update via USB stick requires the correct folder structure as well as the correct file name of the update file. If a different file name is used, the update file will not be recognized and the EMIS4 will not carry out an update.

- Case sensitive!

- Update file name
 - o “rmtt_application.tar”

- ☐ To start the update via USB stick, connect a prepared USB stick to the EMIS4 when the EMIS4 is switched on. If the EMIS4 detects a valid update file in the update folder, the file is automatically transmitted to the EMIS4.
- ☐ The red LED “L17” is activated for the duration of the transmission process and the update preparations.
- ☐ Once the update file has been transmitted from the USB stick to the EMIS4, the EMIS4 starts the update. During this time, all LEDs except the power LED are deactivated.
- ☐ The EMIS4 will restart automatically once the update is complete.
- ☐ To prevent the update from restarting, the USB stick should now be removed.

**NOTE:**

The current version of the EMIS4 can be checked in the device information.

17.2 Update via FTP download

- ☐ As an alternative to local update via USB stick, the EMIS4 can also be updated via the service FTP server.
- ☐ Once the EMIS4 has been switched on, it checks whether an update file is available on the service FTP server. If there is and the version available is newer than the version currently in use, the EMIS4 starts the download immediately.
- ☐ Once the update file has been transmitted, the EMIS4 starts the update. During this time, all LEDs except the power LED are deactivated.
- ☐ The update file to the service FTP server must have the name format “rmtt-updatebundle_<x>.tar”, where <x> is a consecutive number defined by TechnipFMC. For example: “updatebundle_21.tar” for the update to V3.25.0.
 - Case sensitive!
 - Update file name
 - o Example: “rmtt_application_21.tar”

**NOTE:**

The current version of the EMIS4 can be checked in the device information.

18 Monitoring – Sensor Monitoring

- ☐ 2 different versions of sensor monitoring are supported
- ☐ EMIS4 in combination with MultiFlow
 - MultiFlow is responsible for monitoring the sensor inputs
 - Sensor monitoring with a maximum of one MFSI sensor interface
- ☐ EMIS4 without MultiFlow
 - The EMIS4 is responsible for monitoring the sensor inputs
 - Sensor monitoring with a maximum of 2 sensor interfaces and 2 residual quantity interfaces
- ☐ As monitoring is not directly supported by the FTL standard, [1] the parameters required for configuration are only available in the FAS path.
- ☐ It is recommended that Windows tools such as “EMISOrganizer” or “EMIS4Configurator” are used for the configurations of the respective monitoring type required on the EMIS4.

18.1 General Information

- ☐ The “**enable**” parameter for general (de)activation of the respective monitoring function is located in the FAS node:

Nodes: FAS/MONITORING/SETUP

Name	Description	Storage	Data Type	Access	Data Type	Add. Info.
Enable	General deactivation of sensor monitoring or definition of the sensor monitoring type	NV	PA	RD/WR	N1	0: “OFF” (default) 1: “MultiFlow monitoring” 2: “EMIS4 monitoring”

18.2 MultiFlow Monitoring

- ☐ Monitoring is carried out solely by the MultiFlow. The EMIS4 is solely for the transmission of sensor changes detected by the MultiFlow to the FTP server.
- ☐ The monitoring function of the MultiFlow does not behave like a true SPD system, such as the MultiSeal. It monitors only the status of the configured inputs from the connected sensor interface (MFSI), evaluates offline status changes, and records them in the internal logbook of the MultiFlow. These logbook entries are not sent to the EMIS4 automatically, but must be queried by the EMIS4.
- ☐ The EMIS4 then checks the MultiFlow logbook at intervals; the latter can be configured. Sensor changes detected by the MultiFlow and recorded in the MultiFlow logbook are adopted by the EMIS4, saved in an events file, and sent to the configured FTP server. This type of sensor monitoring is referred to as **MultiFlow monitoring**.
- ☐ The MultiFlow is responsible for converting logbook data into FTL format. The EMIS4 only queries the MultiFlow logbook and transmits the data to the FTP server.
- ☐ With MultiFlow monitoring, a maximum of 1 sensor interface (MFSI) is supported.

18.2.1 Configuration

- ☐ With MultiFlow monitoring, the actual sensor monitoring and, therefore, a large proportion of the configuration is carried out in the MultiFlow. Detailed information on configuration of sensor monitoring in the MultiFlow is provided in the corresponding MultiFlow operating instructions [4].
- ☐ In addition to general activation of MultiFlow monitoring, the interval at which the EMIS4 periodically queries the logbook of the MultiFlow must also be defined in the EMIS4.
- ☐ The logbook is only queried when the MultiFlow is idle. If the MultiFlow is currently submitting, for example, the EMIS4 will not send any logbook queries.

Nodes: FAS/MONITORING/SETUP

Name	Description	Storage	Data Type	Access	Data Type	Add. Info.
Interval	Interval for	NV	PA	RD/WR	N2	1 to 99 min

Name	Description	Storage	Data Type	Access	Data Type	Add. Info.
	querying the MultiFlow logbook (valid for "MultiFlow monitoring" only)					Default: "5"

18.3 EMIS4 Monitoring

- ☐ If neither the MultiFlow, MultiSeal, MultiLevel, nor NoMix is connected to the EMIS4 via the CAN bus, a simple sensor monitoring system can be installed by connecting a maximum of 2 sensor and/or a maximum of 2 residual quantity interfaces to the EMIS4. This combination is referred to as **EMIS4 monitoring**.
- ☐ In this mode, no further CAN master system, such as the MultiLevel, MultiFlow, NoMix, or MultiSeal, can be connected to the EMIS4 via the CAN bus.
- ☐ Monitoring and interpretation of sensor changes, as well as conversion into FTL format, are carried out by the EMIS4. Consequently, configuration must be carried out in the EMIS4

Nodes: FAS/MONITORING/SETUP

Name	Description	Storage	Data Type	Access	Data Type	Add. Info.
WLEG_CONF	Definition of parameter L0610 „wleg_conf” from the FTL standard. Setting has no impact on the general function, it only defines the transferred content of this parameter.	NV	PA	RD/WR	N1	0: No wetleg sensor 1: 1 sensor at the bottom of every pipe 2: 1 sensor left, 1 sensor right, both at the bottom 3: 1 sensor at the bottom, 1 sensor at the top 4: 1 sensor per compartment 5: Combination 4+1 6: Combination 4+2 7: Combination 4+3 8: additional config with >=4 sensors Default: '0'

Name	Description	Storage	Data Type	Access	Data Type	Add. Info.
GPSWait	Max. system start delay when no GPS information is available.	NV	PA	RD/WR	N3	0..600s
RecTimeErr	Documentation of memory problems on the SPD interface. Incorrect time stamps for offline events are recorded in the event file using a 9er record	NV	PA	RD/WR	B	0: OFF 1: ON Default: ,0'

18.3.1 Configuration Sensor-Interface

 A maximum of 2 sensor interfaces [5] can be used in EMIS4 monitoring mode.

18.3.1.1 General Settings

 A number of specifications can be defined for the sensor interface. These apply to all connected sensor interfaces.

Node: FAS/MONITORING/SPDINTERFX/SETUP

Name	Description	Storage	Data Type	Access	Data Type	Add. Info.
SwWatchdog	Interface timeout for automatic changeover to "offline mode" when communication with the EMIS4 is	NV	PA	RD/WR	N5	"0": Off, 1 to 65535 *10 ms. Default: "100"

Name	Description	Storage	Data Type	Access	Data Type	Add. Info.
	interrupted					
ScInterval	Average interval for scanning the sensor inputs when the power supply is switched off	NV	PA	RD/WR	N5	1 to 65535 s. Default: "60"
FrameDelay	Delay time between sending individual frames on the CAN bus	NV	PA	RD/WR	N3	1 to 255 ms Default: "50"

18.3.1.2 Sensor Configuration

- ☐ 20 inputs are available per sensor interface. All inputs can be freely configured.
- ☐ Sensor configuration of the two sensor interfaces is carried out in 2 separate nodes.
- ☐ The following sensors are available:
 - Floor valve
 - API link
 - Dome cover
 - Straightway valve
 - Cabinet flap
 - Handbrake
- ☐ An optional chamber number can be added to each sensor input for unique assignment.
- ☐ In the event of multiple, identical sensors, an optional index can be added to each sensor input.
- ☐ The sensor interface supports digital and Namur sensors. The following specifications are supported:
 - Digital NC
 - Digital NO

- Namur NC
- Namur NO

 The sensor events are converted into FTL format by the EMIS4 and transmitted to the FTP server as part of the events file.

Node: FAS/MONITORING/SPDINTERF1/SENSORCONF/IN

Node: FAS/MONITORING/SPDINTERF2/SENSORCONF/IN

Name	Description	Storage	Data Type	Access	Data Type	Add. Info.
Sensor (m)	General activation and function assignment of the sensor input <m> (1 - 20)	NV	PA	RD/WR	N1	0: Not used 1: Floor valve 2: API 3: Dome cover 4: Straight way valve 5: Cabinet flap 6: Handbrake Default: 0
Comp(m)	Chamber number of the sensor used at the sensor input <m>	NV	PA	RD/WR	N2	0: Not used 1 - 24 Default: 0
Index(m)	Sensor index of the sensor used at the sensor input <m>	NV	PA	RD/WR	N1	0 - 9 Default: 0
Type(m)	Type of the sensor used at the sensor input <m>	NV	PA	RD/WR	N1	0: Digital NC 1: Digital NO 2: Namur NC 3: Namur NO Default: 0

18.3.1.3 Interface Information

 In the case of fault-free communication with the connected and configured sensor interfaces, the current device information can be retrieved.

Node: FAS/MONITORING/SPDINTERF1/DEVICE

Node: FAS/MONITORING/SPDINTERF2/DEVICE

Name	Description	Storage	Data Type	Access	Data Type	Add. Info.
HWVersion	Sensor interface hardware version	VO	PP	RD	C10	
SWVersion	Sensor interface software version	VO	PP	RD	C10	
Node	Sensor interface CAN bus address	VO	PP	RD	N4	

18.3.1.4 Interface Status

 The status reported by the respective sensor interface can be monitored via a separate node for each interface.

Node: FAS/MONITORING/SPDINTERF1/STATUS

Node: FAS/MONITORING/SPDINTERF2/STATUS

Name	Description	Storage	Data Type	Access	Data Type	Add. Info.
ResetState	Reset status of the sensor interface	-	OP	RD	B	“0”: OFF “1”: ON
RomError	ROM error status of the sensor interface	-	OP	RD	B	“0”: OFF “1”: ON
RamError	RAM error status of the sensor interface	.	OP	RD	B	“0”: OFF “1”: ON
HwWatchdog	Hardware watchdog status of the sensor interface	-	OP	RD	B	“0”: OFF “1”: ON
SwWatchdog	Software watchdog status of the sensor interface	VO	PP	RD	B	“0”: OFF “1”: ON
CanError	CAN error status of the	VO	PP	RD	B	“0”: OFF “1”: ON

Name	Description	Storage	Data Type	Access	Data Type	Add. Info.
	sensor interface					

18.3.1.5 Current Status

 Independent of the changes to the sensor statuses, the current statuses of the configured inputs of the respective sensor interface can be determined. This is accomplished via a separate subnode.

Node: FAS/MONITORING/SPDINTERF1/AUX

Node: FAS/MONITORING/SPDINTERF2/AUX

Name	Description	Storage	Data Type	Access	Data Type	Add. Info.
InAll	20-digit chain of numbers that reflects the status of each individual sensor input E.g., "10301011320001110100"	-	OP	RD	N20	"0": Open "1": Closed "2": Interrupted "3": Short-circuited "4": Not known
In(m)	<u>Without index specification:</u> 20-digit chain of numbers that reflects the status of each individual sensor input E.g., "10301011320001110100" <u>With index specification:</u> Status of input <m> E.g., In(0) = "1" In(1) = "0" In(2) = "3" ... <m> = 1 - 20	-	OP	RD	N1	"0": Open "1": Closed "2": Interrupted "3": Short-circuited "4": Not known

18.3.1.6 Offline Events

 The internal battery in the sensor interface enables the interface to monitor the sensor inputs at the configured interval, even when the power supply is off [5].

- ☐ Sensor changes detected when the system is off are referred to as offline events.
- ☐ As soon as the EMIS4 is switched on, it checks whether offline events are available at one of the connected sensor interfaces. These are recorded as “*historical data*” in the FTL events file.

18.3.1.7 Snapshot

- ☐ To make later evaluation more straightforward, the current sensor statuses of all configured sensors are determined immediately after switch-on.
- ☐ The current sensor statuses are recorded as a “*snapshot*” in the events file.

18.3.2 Configuration Wetleg-Interface

- ☐ A maximum of 2 wetleg-interfaces [6] can be operated in EMIS4-Monitoring mode.

18.3.2.1 General Settings

- ☐ A number of specifications can be defined for the residual quantity interfaces. These apply to all connected residual quantity interfaces.

Node: FAS/MONITORING/WETINTERFX/SETUP

Name	Description	Storage	Data Type	Access	Data Type	Add. Info.
SwWatchdog	Interface timeout for automatic changeover to “offline mode” when communication with the EMIS4 is interrupted	NV	PA	RD/WR	N5	“0”: Off, 1 to 65535 *10 ms. Default: “100”
FrameDelay	Delay time between sending individual frames on the CAN bus	NV	PA	RD/WR	N3	1 to 255 ms Default: “50”

18.3.2.2 Sensor Configuration

- ☐ 6 inputs are available for wetleg sensors for each Wetleg-Interface. All inputs can be freely configured.
- ☐ 2 digital inputs are available per Wetleg-Interface. All inputs can be freely configured.
- ☐ The sensor configuration of the 2 Wetleg-Interfaces is carried out in 2 separate nodes.
- ☐ An optional chamber number can be added to each sensor input for unique assignment.
- ☐ In case of multiple, identical sensors, an optional index can be configured to each sensor input.
- ☐ The sensor events are converted into FTL format by the EMIS4 and transmitted to the FTP server as part of the event file.

Node: FAS/MONITORING/WETINTERF1/SENSORCONF/WETIN

Node: FAS/MONITORING/WETINTERF2/SENSORCONF/WETIN

Name	Description	Storage	Data Type	Access	Data Type	Add. Info.
Sensor (m)	General activation and function assignment of the sensor at the residual quantity sensor input <m> <x> (1 - 6)	NV	PA	RD/WR	N1	0: Not used 1: Used Default: 0
Comp(m)	Chamber number of the sensor used at the sensor input <m>	NV	PA	RD/WR	N2	0: Not used 1 - 24 Default: 0
Index(m)	Sensor index of the sensor used at the sensor input <m>	NV	PA	RD/WR	N1	0 - 9 Default: 0

Node: FAS/MONITORING/WETINTERF1/SENSORCONF/IN

Node: FAS/MONITORING/WETINTERF2/SENSORCONF/IN

Name	Description	Storage	Data Type	Access	Data Type	Add. Info.
Sensor(m)	General activation and function assignment of the sensor at the digital sensor input <m> <m> (1 - 2)	NV	PA	RD/WR	N1	0: Not used 1: Main compressed air Default: 0
Comp(m)	Chamber number of the sensor used at the digital sensor input <m>	NV	PA	RD/WR	N2	0: Not used 1 - 24 Default: 0
Index(m)	Sensor index of the sensor used at the digital sensor input <m>	NV	PA	RD/WR	N1	0 - 9 Default: 0

18.3.2.3 Interface Information

 In the case of fault-free communication with the connected and configured sensor interfaces, the current device information can be retrieved.

Node: FAS/MONITORING/WETINTERF1/DEVICE

Node: FAS/MONITORING/WETINTERF2/DEVICE

Name	Description	Storage	Data Type	Access	Data Type	Add. Info.
HWVers	Residual quantity	VO	PP	RD	C10	

Name	Description	Storage	Data Type	Access	Data Type	Add. Info.
ion	interface hardware version					
SWVersion	Residual quantity interface software version	VO	PP	RD	C10	
Node	Residual quantity interface CAN bus address	VO	PP	RD	N4	

18.3.2.4 Interface Status

 The status reported by the respective residual quantity sensor interface can be monitored via a separate node for each interface.

Node: FAS/MONITORING/WETINTERF1/STATUS

Node: FAS/MONITORING/WETINTERF2/STATUS

Name	Description	Storage	Data Type	Access	Data Type	Add. Info.
ResetState	Reset status of the residual quantity interface	-	OP	RD	B	"0": OFF "1": ON
RomError	ROM error status of the residual quantity interface	-	OP	RD	B	"0": OFF "1": ON
RamError	RAM error status of the residual quantity interface	-	OP	RD	B	"0": OFF "1": ON
HwWatchdog	Hardware watchdog status of the residual quantity	-	OP	RD	B	"0": OFF "1": ON

Name	Description	Storage	Data Type	Access	Data Type	Add. Info.
	interface					
SwWatchdog	Software watchdog status of the residual quantity interface	VO	PP	RD	B	"0": OFF "1": ON
CanError	CAN error status of the residual quantity interface	VO	PP	RD	B	"0": OFF "1": ON

18.3.2.5 Current Status

 Independent of the changes to the sensor statuses, the current statuses of the configured inputs of the respective residual quantity interface can be determined. This is accomplished via a separate subnode.

Node: FAS/MONITORING/WETINTERF1/AUX

Node: FAS/MONITORING/WETINTERF2/AUX

Name	Description	Storage	Data Type	Access	Data Type	Add. Info.
InWetAll	6-digit chain of numbers that reflects the status of each residual quantity sensor input of the residual quantity interface E.g., "103000"	-	OP	RD	N6	"0": Open "1": Closed "2": Interrupted "3": Short-circuited "4": Not known
InWet(m)	<u>Without index specification:</u> 6-digit chain of numbers that reflects the status of each residual quantity sensor input of the residual quantity interface	-	OP	RD	N1	"0": Open "1": Closed "2": Interrupted "3": Short-circuited "4": Not known

Name	Description	Storage	Data Type	Access	Data Type	Add. Info.
	<p>E.g., "103000"</p> <p><u>With index specification:</u></p> <p>Status of residual quantity sensor input <m></p> <p>E.g., InWet(0) = "1" InWet(1) = "0" InWet(2) = "3" ...</p>					
InDigAll	<p>2-digit chain of numbers that reflects the status of each digital input of the residual quantity interface</p> <p>E.g., "10"</p>	-	OP	RD	N2	<p>"0": Open "1": Closed "2": Interrupted "3": Short-circuited "4": Not known</p>
InDig(m)	<p><u>Without index specification:</u></p> <p>2-digit chain of numbers that reflects the status of each digital input of the residual quantity interface</p> <p>E.g., "10"</p> <p><u>With index specification:</u></p> <p>Status of the digital input <m></p> <p>E.g., InDig (0) = "1" InDig (1) = "0"</p>	-	OP	RD	N1	<p>"0": Open "1": Closed "2": Interrupted "3": Short-circuited "4": Not known</p>

18.3.2.6 Snapshot

- ☐ To make later evaluation more straightforward, the current sensor statuses of all configured residual quantity and digital sensors are determined immediately after switch-on.
- ☐ The current sensor statuses are recorded as a “*snapshot*” in the events file.

18.4 Event File Transfer

- ☐ The transmission behavior during monitoring (i.e., definition of when events files are transmitted to the FTP server) can be defined with the “**UploadInt**” and “**EventLimit**” parameters.
- ☐ Definition of when the events files are transmitted is independent of the respective monitoring type used.

Node: FAS/MONITORING/SETUP

Name	Description	Storage	Data Type	Access	Data Type	Add. Info.
UploadInt	Time interval for sending FTL events file to the FTP server	NV	PA	RD/WR	N5	10 to 86400 sec Default: “600”
EventLimit	Max. events per events file. When reached, the FTL events file is transmitted to the FTP server	NV	PA	RD/WR	N2	1 to 9999 Default: “20”

- ☐ Both “**UploadInt**” and “**EventLimit**” are used to adapt the sending behavior to the customer’s requirements with as much flexibility as possible. When one of these conditions is satisfied, transmission of the events file to the FTP server is triggered.
- ☐ In the event that file transmission is initiated due to the timeout specified with “**UploadInt**” being reached, without any further events having occurred since the last transmission, a blank events file is transmitted. This blank events file will contain only the pure FTL header with no further sensor information.
- ☐ The interval defined with “**UploadInt**” determines the period of time at the latest after which an events file (with or without sensor events) is transmitted. This can be used to as a “heartbeat” function, as the EMIS4 transmits events files at regular intervals, even without sensor changes having been detected. The presence of these events files on the FTP server can be used to determine whether or not an EMIS4 system is functioning according to its specifications and is online.



NOTE:

In the event that the EMIS4 detects communication problems with the

MultiFlow, no events files are transmitted to the FTP server. This enables communication problems on the CAN bus to be detected remotely.



NOTE:

Offline-Event and Snapshot data will always be completely sent within the same event file. The max. event size, defined by parameter “EventLimit”, will be ignored for this type of events.

18.5 EMIS4 example configuration



NOTE:

Example configuration in FTL command format.



NOTE:

Parameter which are not listed within the example configuration are assumed to be set to 0".

18.5.1 MultiFlow-Monitoring



NOTE:

For MultiFlow-Monitoring, the configuration of the sensor-interface (MFSI) is part of the MultiFlow configuration. See MultiFlow manual [4].

Configuration:

- Check of the MultiFlow logbook every 5min
- Event file transmission every 10min or at >= 50 sensor events

SET,FAS,MONITORING,SETUP,ENABLE=1

SET,FAS,MONITORING,SETUP,INTERVAL=5

SET,FAS,MONITORING,SETUP,UPLOADINT=600

SET,FAS,MONITORING,SETUP,EVENTLIMIT=50

18.5.2 EMIS4-Monitoring

Configuration:

- 1 sensor-interface
 - o 1 bottom valve sensor/compartment
 - o 1 API sensor/compartment
 - o 1 man lid sensor/compartment
 - o 1 sensor cabinet door left
 - o 1 sensor cabinet door right
 - o 1 sensor break
 - o All sensors are type „Digital NO“
- 1 wetleg-interface
 - o 1 wetleg sensor/compartment
 - o 1 main air pressure sensor
- 4 compartments
- Event file transmission every 10min or at >= 50 sensor events

```
SET,FAS,MONITORING,SETUP,ENABLE=2
SET,FAS,MONITORING,SETUP,UPLOADINT=600
SET,FAS,MONITORING,SETUP,EVENTLIMIT=50
```

```
SET,FAS,MONITORING,SPDINTERFX,SETUP,SWATCHDOG=100
SET,FAS,MONITORING,SPDINTERFX,SETUP,FRAMEDELAY=50
SET,FAS,MONITORING,SPDINTERFX,SETUP,SCINTERVAL=10
SET,FAS,MONITORING,WETINTERFX,SETUP,SWATCHDOG=100
SET,FAS,MONITORING,WETINTERFX,SETUP,FRAMEDELAY=50
```

```
SET,FAS,MONITORING,SPDINTERF1,SENSORCONF,IN,SENSOR(1)=1
SET,FAS,MONITORING,SPDINTERF1,SENSORCONF,IN,COMP(1)=1
SET,FAS,MONITORING,SPDINTERF1,SENSORCONF,IN,INDEX(1)=0
SET,FAS,MONITORING,SPDINTERF1,SENSORCONF,IN,TYPE(1)=1
SET,FAS,MONITORING,SPDINTERF1,SENSORCONF,IN,SENSOR(2)=1
SET,FAS,MONITORING,SPDINTERF1,SENSORCONF,IN,COMP(2)=2
SET,FAS,MONITORING,SPDINTERF1,SENSORCONF,IN,INDEX(2)=0
SET,FAS,MONITORING,SPDINTERF1,SENSORCONF,IN,TYPE(2)=1
SET,FAS,MONITORING,SPDINTERF1,SENSORCONF,IN,SENSOR(3)=1
SET,FAS,MONITORING,SPDINTERF1,SENSORCONF,IN,COMP(3)=3
SET,FAS,MONITORING,SPDINTERF1,SENSORCONF,IN,INDEX(3)=0
SET,FAS,MONITORING,SPDINTERF1,SENSORCONF,IN,TYPE(3)=1
SET,FAS,MONITORING,SPDINTERF1,SENSORCONF,IN,SENSOR(4)=1
SET,FAS,MONITORING,SPDINTERF1,SENSORCONF,IN,COMP(4)=4
SET,FAS,MONITORING,SPDINTERF1,SENSORCONF,IN,INDEX(4)=0
SET,FAS,MONITORING,SPDINTERF1,SENSORCONF,IN,TYPE(4)=1
SET,FAS,MONITORING,SPDINTERF1,SENSORCONF,IN,SENSOR(5)=2
SET,FAS,MONITORING,SPDINTERF1,SENSORCONF,IN,COMP(5)=1
SET,FAS,MONITORING,SPDINTERF1,SENSORCONF,IN,INDEX(5)=0
SET,FAS,MONITORING,SPDINTERF1,SENSORCONF,IN,TYPE(5)=1
SET,FAS,MONITORING,SPDINTERF1,SENSORCONF,IN,SENSOR(6)=2
SET,FAS,MONITORING,SPDINTERF1,SENSORCONF,IN,COMP(6)=2
SET,FAS,MONITORING,SPDINTERF1,SENSORCONF,IN,INDEX(6)=0
SET,FAS,MONITORING,SPDINTERF1,SENSORCONF,IN,TYPE(6)=1
SET,FAS,MONITORING,SPDINTERF1,SENSORCONF,IN,SENSOR(7)=2
SET,FAS,MONITORING,SPDINTERF1,SENSORCONF,IN,COMP(7)=3
SET,FAS,MONITORING,SPDINTERF1,SENSORCONF,IN,INDEX(7)=0
SET,FAS,MONITORING,SPDINTERF1,SENSORCONF,IN,TYPE(7)=1
SET,FAS,MONITORING,SPDINTERF1,SENSORCONF,IN,SENSOR(8)=2
SET,FAS,MONITORING,SPDINTERF1,SENSORCONF,IN,COMP(8)=4
SET,FAS,MONITORING,SPDINTERF1,SENSORCONF,IN,INDEX(8)=0
SET,FAS,MONITORING,SPDINTERF1,SENSORCONF,IN,TYPE(8)=1
SET,FAS,MONITORING,SPDINTERF1,SENSORCONF,IN,SENSOR(9)=3
SET,FAS,MONITORING,SPDINTERF1,SENSORCONF,IN,COMP(9)=1
SET,FAS,MONITORING,SPDINTERF1,SENSORCONF,IN,INDEX(9)=0
SET,FAS,MONITORING,SPDINTERF1,SENSORCONF,IN,TYPE(9)=1
SET,FAS,MONITORING,SPDINTERF1,SENSORCONF,IN,SENSOR(10)=3
```

SET,FAS,MONITORING,SPDINTERF1,SENSORCONF,IN,COMP(10)=2
SET,FAS,MONITORING,SPDINTERF1,SENSORCONF,IN,INDEX(10)=0
SET,FAS,MONITORING,SPDINTERF1,SENSORCONF,IN,TYPE(10)=1
SET,FAS,MONITORING,SPDINTERF1,SENSORCONF,IN,SENSOR(11)=3
SET,FAS,MONITORING,SPDINTERF1,SENSORCONF,IN,COMP(11)=3
SET,FAS,MONITORING,SPDINTERF1,SENSORCONF,IN,INDEX(11)=0
SET,FAS,MONITORING,SPDINTERF1,SENSORCONF,IN,TYPE(11)=1
SET,FAS,MONITORING,SPDINTERF1,SENSORCONF,IN,SENSOR(12)=3
SET,FAS,MONITORING,SPDINTERF1,SENSORCONF,IN,COMP(12)=4
SET,FAS,MONITORING,SPDINTERF1,SENSORCONF,IN,INDEX(12)=0
SET,FAS,MONITORING,SPDINTERF1,SENSORCONF,IN,TYPE(12)=1
SET,FAS,MONITORING,SPDINTERF1,SENSORCONF,IN,SENSOR(13)=4
SET,FAS,MONITORING,SPDINTERF1,SENSORCONF,IN,COMP(13)=1
SET,FAS,MONITORING,SPDINTERF1,SENSORCONF,IN,INDEX(13)=0
SET,FAS,MONITORING,SPDINTERF1,SENSORCONF,IN,TYPE(13)=1
SET,FAS,MONITORING,SPDINTERF1,SENSORCONF,IN,SENSOR(14)=4
SET,FAS,MONITORING,SPDINTERF1,SENSORCONF,IN,COMP(14)=2
SET,FAS,MONITORING,SPDINTERF1,SENSORCONF,IN,INDEX(14)=0
SET,FAS,MONITORING,SPDINTERF1,SENSORCONF,IN,TYPE(14)=1
SET,FAS,MONITORING,SPDINTERF1,SENSORCONF,IN,SENSOR(15)=4
SET,FAS,MONITORING,SPDINTERF1,SENSORCONF,IN,COMP(15)=3
SET,FAS,MONITORING,SPDINTERF1,SENSORCONF,IN,INDEX(15)=0
SET,FAS,MONITORING,SPDINTERF1,SENSORCONF,IN,TYPE(15)=1
SET,FAS,MONITORING,SPDINTERF1,SENSORCONF,IN,SENSOR(16)=4
SET,FAS,MONITORING,SPDINTERF1,SENSORCONF,IN,COMP(16)=4
SET,FAS,MONITORING,SPDINTERF1,SENSORCONF,IN,INDEX(16)=0
SET,FAS,MONITORING,SPDINTERF1,SENSORCONF,IN,TYPE(16)=1
SET,FAS,MONITORING,SPDINTERF1,SENSORCONF,IN,SENSOR(17)=0
SET,FAS,MONITORING,SPDINTERF1,SENSORCONF,IN,COMP(17)=0
SET,FAS,MONITORING,SPDINTERF1,SENSORCONF,IN,INDEX(17)=0
SET,FAS,MONITORING,SPDINTERF1,SENSORCONF,IN,TYPE(17)=0
SET,FAS,MONITORING,SPDINTERF1,SENSORCONF,IN,SENSOR(18)=5
SET,FAS,MONITORING,SPDINTERF1,SENSORCONF,IN,COMP(18)=0
SET,FAS,MONITORING,SPDINTERF1,SENSORCONF,IN,INDEX(18)=1
SET,FAS,MONITORING,SPDINTERF1,SENSORCONF,IN,TYPE(18)=1
SET,FAS,MONITORING,SPDINTERF1,SENSORCONF,IN,SENSOR(19)=5
SET,FAS,MONITORING,SPDINTERF1,SENSORCONF,IN,COMP(19)=0
SET,FAS,MONITORING,SPDINTERF1,SENSORCONF,IN,INDEX(19)=2
SET,FAS,MONITORING,SPDINTERF1,SENSORCONF,IN,TYPE(19)=1
SET,FAS,MONITORING,SPDINTERF1,SENSORCONF,IN,SENSOR(20)=6
SET,FAS,MONITORING,SPDINTERF1,SENSORCONF,IN,COMP(20)=0
SET,FAS,MONITORING,SPDINTERF1,SENSORCONF,IN,INDEX(20)=0
SET,FAS,MONITORING,SPDINTERF1,SENSORCONF,IN,TYPE(20)=1

SET,FAS,MONITORING,WETINTERF1,SENSORCONF,IN,SENSOR(1)=1
SET,FAS,MONITORING,WETINTERF1,SENSORCONF,IN,COMP(1)=0
SET,FAS,MONITORING,WETINTERF1,SENSORCONF,IN,INDEX(1)=0

SET,FAS,MONITORING,WETINTERF1,SENSORCONF,WETIN,SENSOR(1)=1
SET,FAS,MONITORING,WETINTERF1,SENSORCONF,WETIN,COMP(1)=1
SET,FAS,MONITORING,WETINTERF1,SENSORCONF,WETIN,INDEX(1)=0
SET,FAS,MONITORING,WETINTERF1,SENSORCONF,WETIN,SENSOR(2)=1
SET,FAS,MONITORING,WETINTERF1,SENSORCONF,WETIN,COMP(2)=2
SET,FAS,MONITORING,WETINTERF1,SENSORCONF,WETIN,INDEX(2)=0
SET,FAS,MONITORING,WETINTERF1,SENSORCONF,WETIN,SENSOR(3)=1
SET,FAS,MONITORING,WETINTERF1,SENSORCONF,WETIN,COMP(3)=3
SET,FAS,MONITORING,WETINTERF1,SENSORCONF,WETIN,INDEX(3)=0
SET,FAS,MONITORING,WETINTERF1,SENSORCONF,WETIN,SENSOR(4)=1
SET,FAS,MONITORING,WETINTERF1,SENSORCONF,WETIN,COMP(4)=4
SET,FAS,MONITORING,WETINTERF1,SENSORCONF,WETIN,INDEX(4)=0

19 Windows Tools

- ☐ A number of Windows applications are available for configuration as well as checking of individual functions of the EMIS4.

19.1 EMIS-Organizer

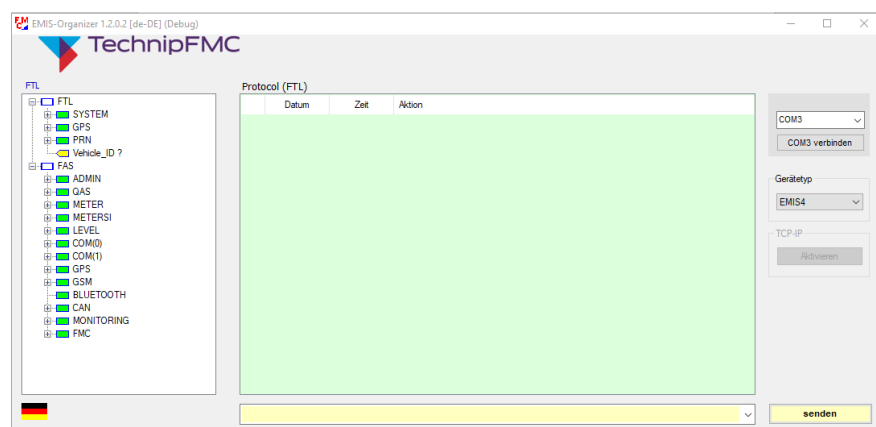



Figure 12: EMIS-Organizer

- ☐ The EMIS-Organizer supports both, the EMIS2 and EMIS4.
- ☐ The EMIS-Organizer provides a direct overview and access to the parameter structure supported by the respective EMIS version.
- ☐ Further details on the EMIS-Organizer can be obtained from TechnipFMC's service department.

19.2 EMIS4-Configurator

Figure 13: EMIS4-Configurator

- ☐ The EMIS4-Configurator can be used to implement basic GSM/GPRS settings and to define access data for the FTP server.
- ☐ The EMIS4-Configurator makes a separate area available for configuration of the monitoring versions.
- ☐ The general setup can be read out and saved by the EMIS4. The EMIS4-Configurator can write saved configurations to the EMIS4.
- ☐ The EMIS4 can read out and save the monitoring setup. The EMIS4-Configurator can write saved monitoring settings to the EMIS4.

 Further details on the EMIS4-Configurator can be obtained from TechnipFMC's service department.

20 Abbreviations

20.1 Storage Classes

Class	Short	Description
Fixed	FI	Value is built-in into software and can only be changed by a software update
Hardware-Adjusted	HA	Value is determined by a hardware setting (e. g. DIP switch or jumper)
Non-Volatile	NV	Value will remain the same after power-up or restart
Volatile	VO	Value will be set to default on every power-up or restart
Other	OT	None of the above

20.2 Data Types

Type	Short	Description
Set Telegram	ST	Value is set by the OBC by means of a SET telegram
Parameter	PA	Value is considered part of the TCD's parameterization
Computed Internally	CI	MultiTask software computes value from internal state
MTS Pushed	MP	Value is sent to the TCD by another MTS device spontaneously, i. e. without being queried by the TCD.
OBC Polled	OP	Value is queried from another MTS device each time the OBC requests it

Polled at Power-up	PP	Field is received from another MTS device only during power-up sequence
GPS	GP	Value is received from a GPS device that is connected to a COM port.
Other	OT	None of the above

20.3 Error Codes

Code	Meaning
0000	No error
1000	Unknown command (OpCode) received
1001	Unknown variable was selected
1002	Telegram transmission failed (NAK received)
1003	Neither ACK nor NAK received for transmitted telegram (acknowledgement absent)
1004	No reply received to REQUEST telegram
1005	Reply to REQUEST telegram faulty or incomplete
1006	Index for variable outside permitted limits Example: Meter.Device(99)
1007	No WaitOff received after WaitOn
2000	Assigned value was truncated (character string too long)
2001	Assigned value not possible (telegram format faulty)
2002	Assigned value not possible (above/below permitted range)
2003	Value assignment not possible (specified parameter invalid)
3000	No write access to selected variable
3001	Write access refused. The device is "Busy"
4000	Internal error : ROM
4001	Internal error : RAM
4002	Internal error : EEPROM
4003	Internal error : Clock
510m	No answer from METER
5110	No answer from QAS
5200	Master METER device not present
5210	No answer from master METER device
6100	LEVEL device not present
6101	LEVEL preset not completed
7000	METERSI device not present
7010	No answer from METERSI device
9998	Unknown value for the variable "Mode"
9999	Unknown error
10010	Event transmission aborted by MTS device
10020	Event transmission canceled by MTS device
10030	Event transmission rejected by MTS device
10040	Event transmission canceled
10050	No response from MTS device
10060	Operation not permitted for delivery data

21 Technical Specifications

Power supply	UN = 24 V (12 - 30 V)/Imax = 500 mA
Network communication (bus)	Ext. CAN bus 100 kBaud Int. CAN bus 50 kBaud
On-board computer connection	Serial interface RS232 Default: 9600 Baud, 8 bit, 1 stop bit, no parity XON/XOFF protocol
GSM antenna	Passive GSM antenna
GPS antenna	Active GPS antenna (Imax = 30 mA)
Bluetooth antenna	Passive Bluetooth
Battery life of backup battery	Typ. 4 hours
Operating temperature	-20 to 60°C
Housing	IP65, aluminum die cast
Ex approval	Ⓔ II 2 G Ex mb eb ib [ib] IIB T4

22 Address and Contact

Our service department would be happy to help you and can be reached at the following:

TechnipFMC

F. A. Sening GmbH

Regentstrasse 1
D-25474 Ellerbek

Tel.: +49 (0)4101 304 - 0 (head office)

Fax: +49 (0)4101 304 - 152 (service)

Fax: +49 (0)4101 304 - 133 (sales)

Fax: +49 (0)4101 304 - 255 (order processing)

E-mail: info@technipfmc.com

Web: www.technipFMC.com

Appendix A Antenna Assembly

Technical specifications:

Dimensions

GSM antenna:

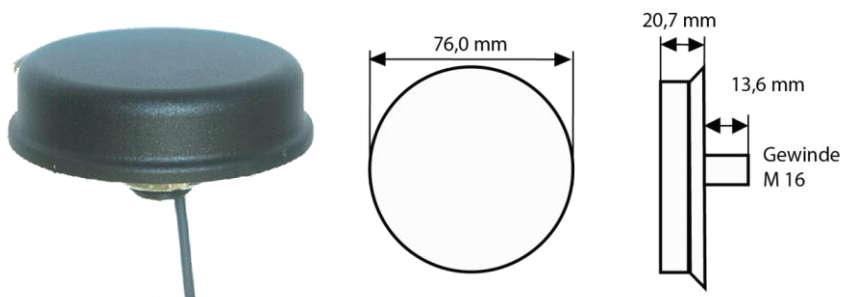

GPS4 receiver:

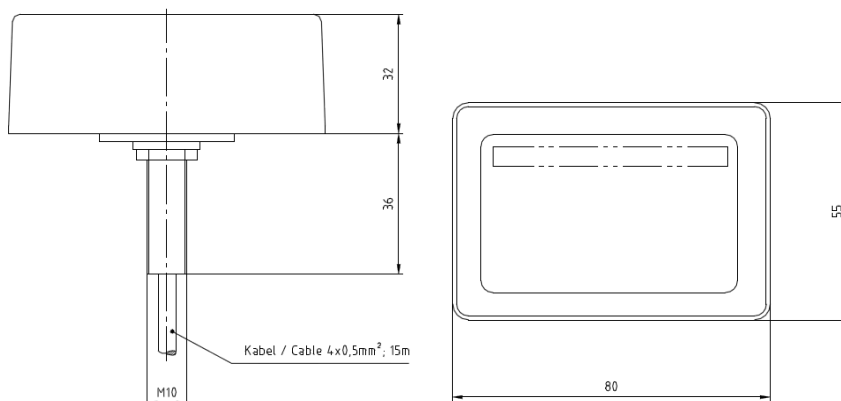

- ▶ **Max. torque:** 5 Nm
- ▶ **GPS4:** 1575.42 MHz/27 dB
- ▶ **GSM:** 900/1800 MHz or 800/1900 MHz

Different antenna types are possible:

- GPS4 antenna
(1 RG 174 cable with cap):
The GPS cable is marked next to the SMA connection with "GPS" or "N70....".
- GSM and Bluetooth antenna
(1 RG 174 cable with cap):
The GPS cable is marked next to the SMA connection with "GSM" or "M70....".

- ☞ The GPS4 antenna requires an unobstructed view to the sky; without this, the satellites cannot be properly detected, and the position cannot be determined. As such, it is a good idea to install the antenna in the upper section of the tanker.
- ☞ GSM and Bluetooth have lower requirements when it comes to antenna positioning. These can also be installed in the lower section of the tanker. In any event, it must be borne in mind that both antennas must be installed in the zone 2 section.

Instructions for antenna assembly

- ▶ The antennas for the EMIS4 are connected to the EMIS by means of SMA connectors.
- ▶ The text below is intended as an aid for installing the antenna cables on the EMIS4.
- ▶ Before installing the antenna cables on the EMIS4, the antenna base must be fully assembled, and the cables fully routed.

1. EMIS4 with GSM and Bluetooth antennas.





<p>1.</p> <p>Connect the GSM antenna</p>	<p>2.</p> <p>Unscrew the cap nut</p>	<p>3.</p> <p>Remove the clamp body</p>
--	--------------------------------------	--

4. 

Remove the sealing ring from the clamp body
5. 

Slide the cap nut onto the antenna cable
6. 

Carefully slide the sealing ring over the antenna connector
7. 

Slide the sealing ring onto the antenna cable
8. 

Slide the clamp body onto the antenna cable
9. 

Press the sealing ring into the clamp body
10. 

The sealing ring must be flush with the clamp body
11. 

Slide the antenna cable through the gland body
12. 

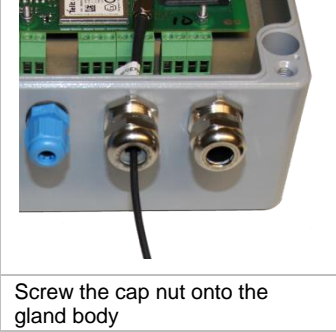
Press the clamp body into the gland body
13. 

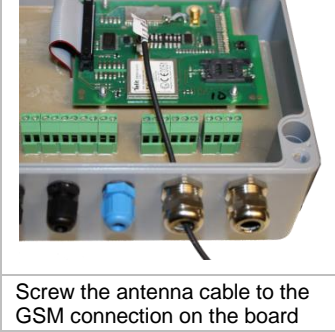
Screw the cap nut onto the gland body
14. 

Screw the antenna cable to the GSM connection on the board
15. 

Tighten the antenna gland



CORRECT
Screw the cap nut tightly to the gland body until the antenna cable is held in place by the sealing ring.

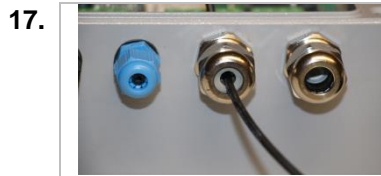

INCORRECT
Cap nut not properly tightened. Sealing ring NOT clamping the antenna cable



Fig. 1: GSM and Bluetooth antenna connected



Fig. 2: Standard: only GSM antenna connected

20. END of assembly.



Index

A			
AI	11		
C			
Cable	11, 12, 13		
Card.....	29		
Commissioning.....	9		
Connector.....	12		
customer number	35		
D			
Data.....	19		
Disposal.....	9		
E			
EMC Declaration of Conformity..	12		
EMIS, connections	20		
EMIS4.....	20		
EMIS4 Monitoring.....	54		
EMIS4-Configurator	73		
EMIS-Organizer.....	72		
F			
Fastening	13		
Function	9		
G			
GSM/GPRS	29		
I			
Installation.....	11		
Intended.....	10		
L			
Liability	10		
M			
MultiFlow Monitoring.....	52		
O			
ONr_L1124.....	35		
order number	35		
P			
Pictograms	8		
S			
Safety	10, 14		
Screw	12		
Service	78		
Service team	10		
SIM card.....	29		
T			
Terminal	12		
W			
Wire-end.....	12		
Orientation.....	8		

23 Drawings

P8000008262 – EMIS4 interface, complete – EMIS4

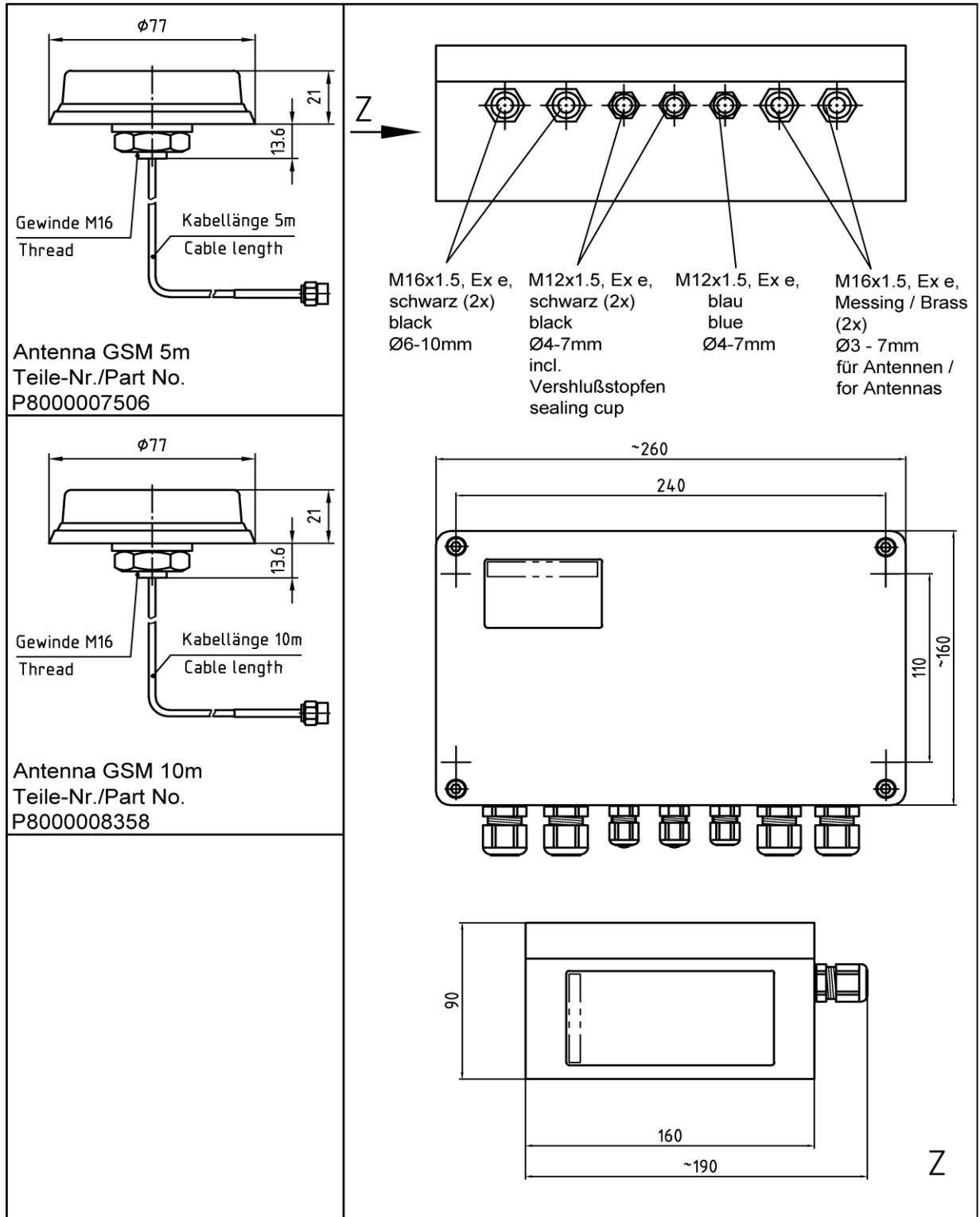

"Schutzvermerk nach DIN ISO 16016 beachten"

ALL TOLERANCED DIMENSIONS ARE FOR INSTALLATION ONLY.
ALL OTHER DIMENSIONS ARE FOR REFERENCE ONLY.

FMC Technologies
F.A. Sening GmbH, Regentstr. 1, 25474 Ellerbek, Germany

Method 1	Method 3	Date / Datum	Name	Item name / Benennung EMIS4 made for / zugehörig zu EMIS4
		Drawn	04.12.2013	
Scale / Maßst.	1:2	Item-No. / Teile-Nr.	Drawing No. / Zeichnungs-Nr.	
Size / Format	ISO - A4	EMIS4	P8000008262	
Weight / Gewicht	3,9 kg		Rev.	000.00

P8000008261 – EMIS4 connections

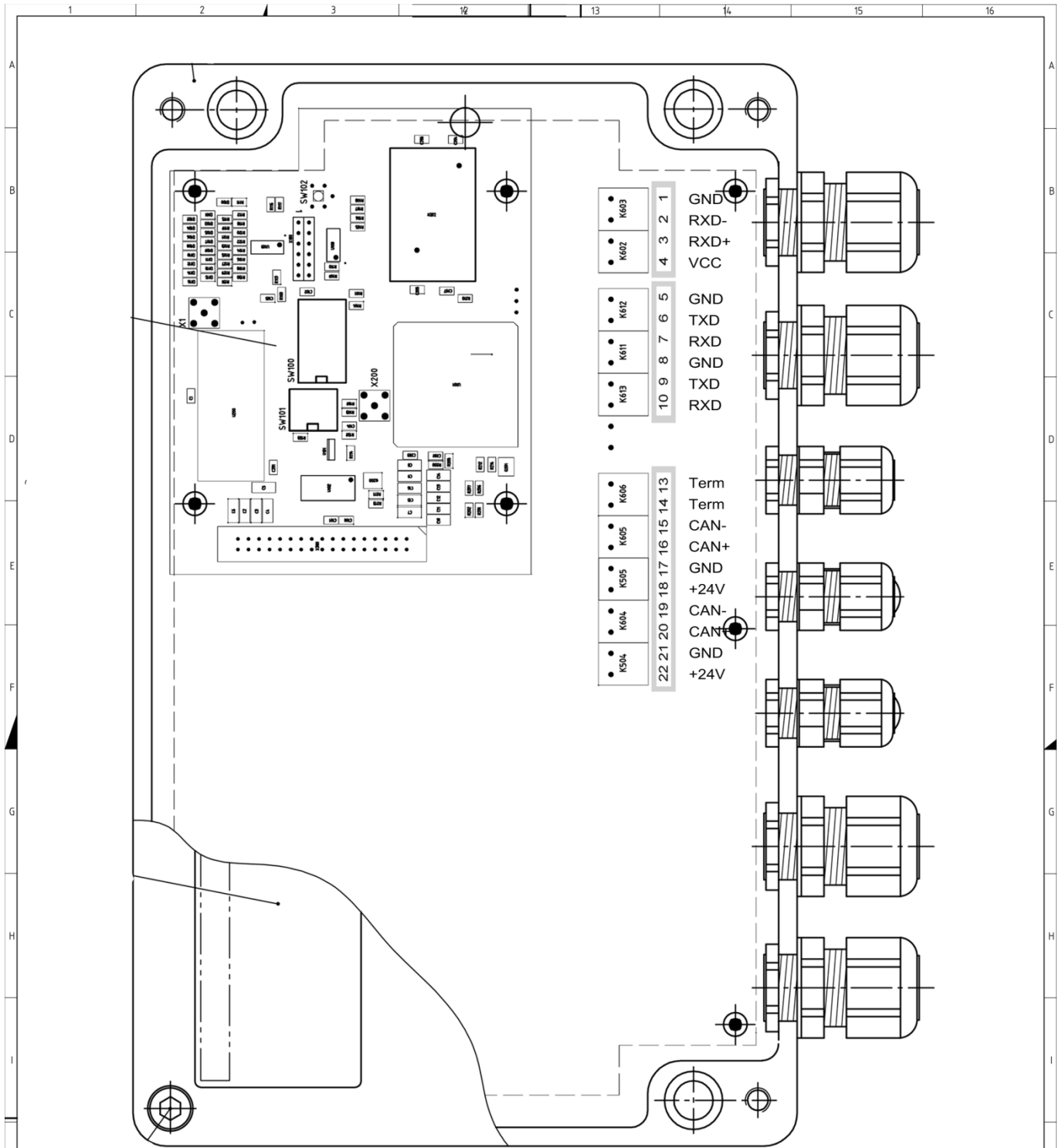

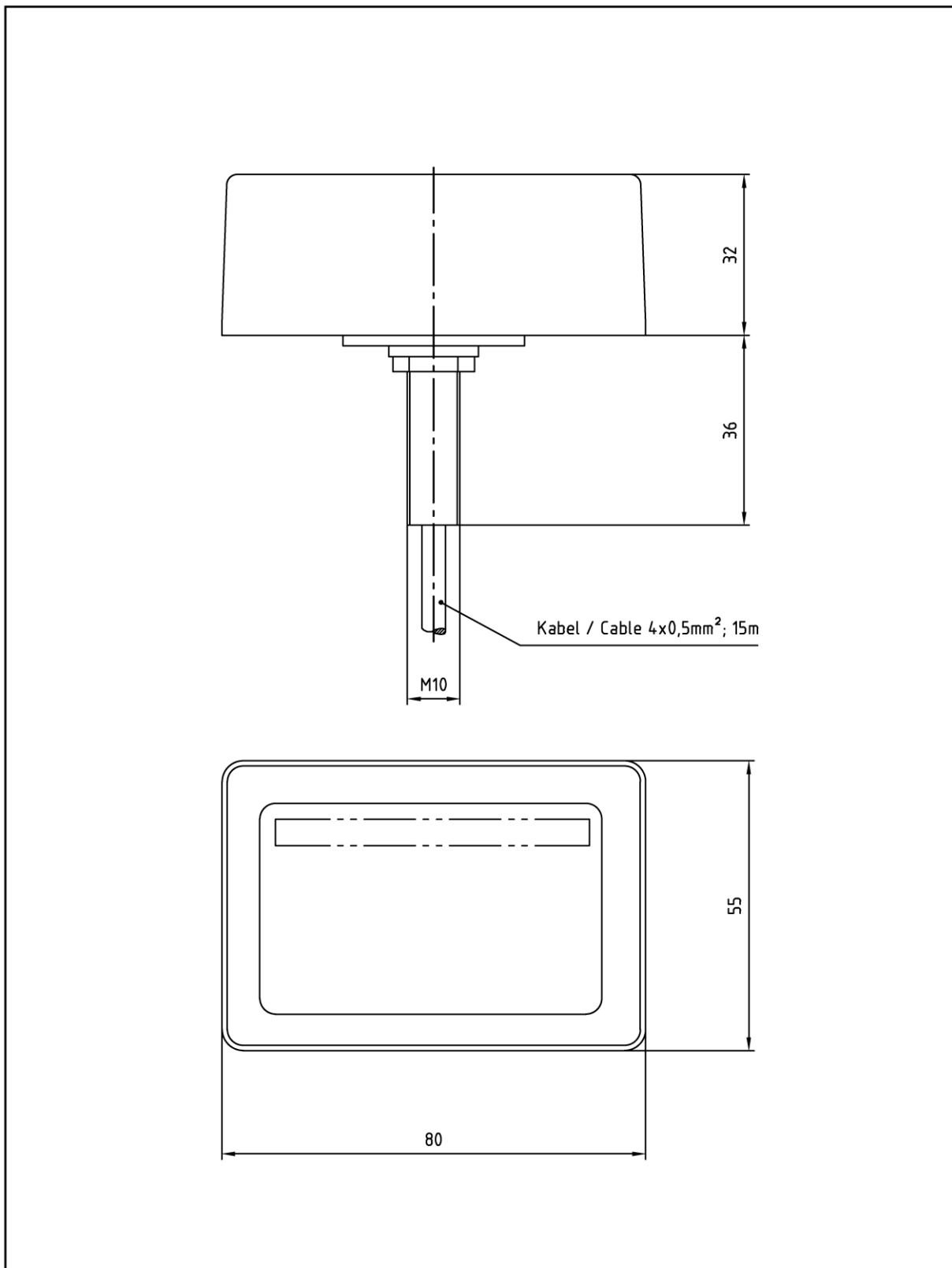

Workpiece edges according to ISO 13715
Werkstückkanten nach ISO 13715

Ref. DWG/Urprungszchg		Dimension Tolerance Allgemeintoleranzen		Surface Texture Oberflächen- zeichen ISO 1302		FMC Technologies F.A.Sening GmbH, Regentstr. 1, 25474 Ellerbek, Germany			
Design Code		ISO 2768-mK							
Projection Method Method 1 Method 3		Date/Datum	Name	Item name / Benennung				Rev.	Sheet / Blatt
		Drawn 28.11.2013 Arndt	Arndt	EMIS4					1
		Checked 28.11.2013 Arndt	Arndt	made for / zugehörig zu komplett / complete					
		Approved		Drawing No. / Zeichnungs-Nr.		P8000008261		000.00	of / von 1
		Item-No. / Teile-Nr.		Material		Weight / Gewicht		Scale / Maßst. 1:1	
		EMIS4				0,0 kg		Size / Format ISO-A1	
		Change/Änder. 80002311	Date/Datum 02.13.2013	Name Larsen					

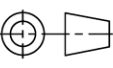

"Copyright protection according to DIN ISO 16016"
 "Schutzvermerk nach DIN ISO 16016 beachten"

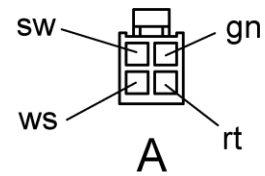
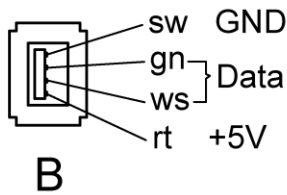
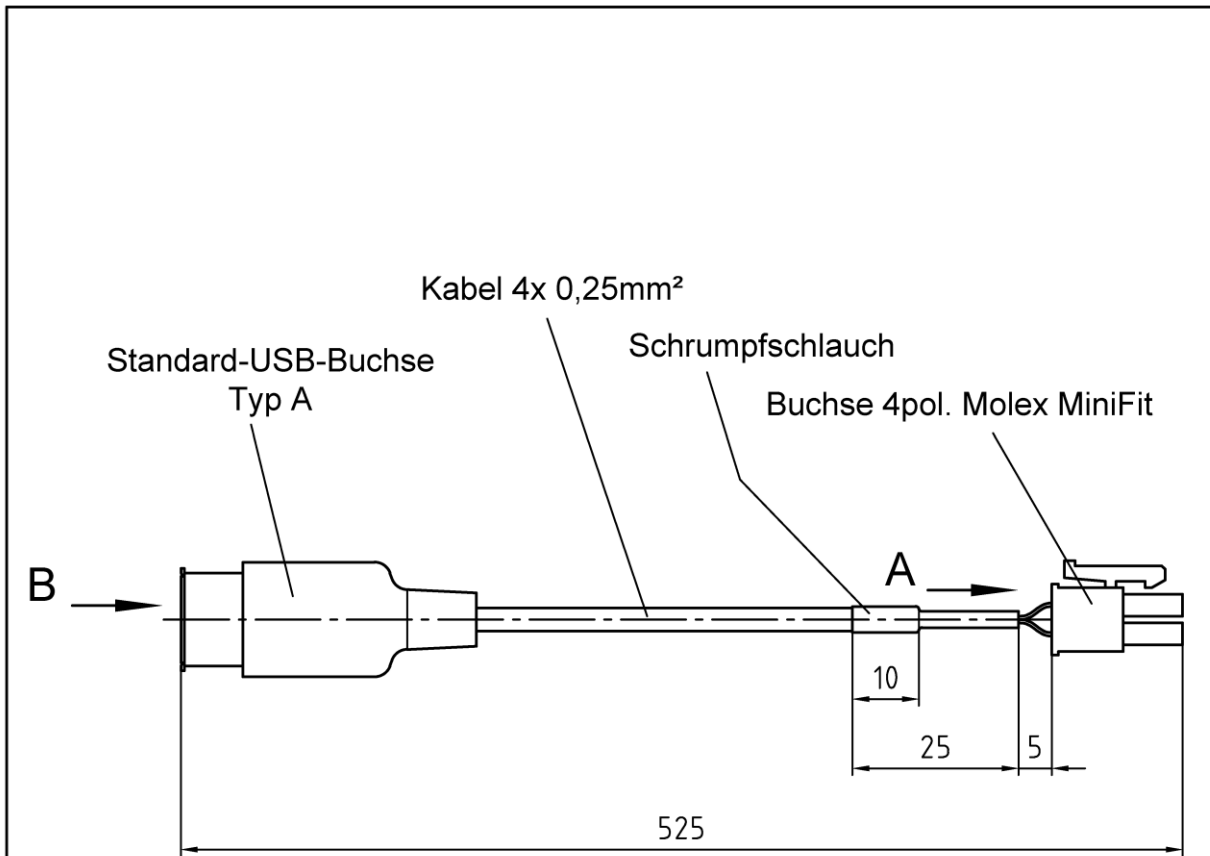

ALL TOLERANCED DIMENSIONS ARE FOR INSTALLATION ONLY. ALL OTHER DIMENSIONS ARE FOR REFERENCE ONLY.				FMC Technologies F.A.Sening GmbH, Regentstr. 1, 25474 Ellerbek, Germany	
Method 1 		Method 3 		Date / Datum Name	
Drawn Checked		11.11.2013 12.11.2013		Larsen Arndt	
Scale / Maßst. 1:1 Size / Format ISO - A4 Weight / Gewicht 0,0 kg		Item-No. / Teile-Nr. GPS4		Item name / Benennung GPS4-Empfänger / Receiver made for / zugehörig zu komplett / complete	
Drawing No. / Zeichnungs-Nr. P8000008083				Rev. 000.00	
				Sheet / Blatt 1 of / von 1	



"Copyright protection according to DIN ISO 16016"
 "Schutzvermerk nach DIN ISO 16016 beachten"

Workpiece edges according to ISO 13715
 Werkstückkanten nach ISO 13715

Lieferant: Fa. Maresch

Ref. DWG/ Ursprungszchg	Dimension Tolerance Allgemeintoleranzen	Surface Texture Oberflächen- zeichen ISO 1302	FMC Technologies F.A.Sening GmbH, Regentstr. 1, 25474 Ellerbek, Germany		
Design Code	ISO 2768-mK				
Projection Method  Method 1  Method 3	Date/Datum	Name	Item name / Benennung		
	Drawn	19.06.2014	Larsen	USB-Servicekabel	
	Checked	20.06.2014	Arndt	made for / zugehörig zu MultiTask und EMIS4	
Item-No. / Teile-Nr.		Drawing No. / Zeichnungs-Nr.		Rev.	Sheet / Blatt
P8000009956		P8000009956		000.00	1 of / von 1
Change/Änder.	Date/Datum	Name	Material	Weight / Gewicht	Scale / Maßst. 1:1
80003415	19.06.2014	Larsen		0,0 kg	Size / Format ISO-A4

24 Approvals

EU Declaration of Conformity - MultiTask / EMIS4

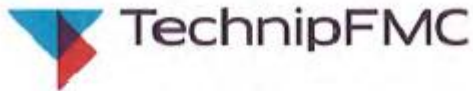

F.A. Sening GmbH
Ellerbek, Germany

EU-Konformitätserklärung Nr.: EU-Declaration of Conformity no.:

KEel 360-5

Für das folgende Produkt:
for the following product:

Zentraleinheit mit / ohne Bediengerät mit Farbdisplay und Touch Screen
Central processing unit with/without HMI interface with color screen and touch screen

Typ: **MultiTask / EMIS4**
Type:

Ausführung: MultiTask / EMIS4 MT.-RMTT-H, MultiTask MT.-HMI-L
Model:

Produktbeschreibung: Überwachung der ordnungsgemäßen Entleerung von Straßentankwagen
Product Description Monitoring the proper emptying of road tankers

Der Hersteller / The Manufacturer

F.A. Sening GmbH, Regentstraße 1, 25474 Ellerbek

erklärt hiermit in alleiniger Verantwortung, dass der Gegenstand dieser Erklärung folgenden einschlägigen Rechtsvorschriften zur Harmonisierung in der Union erfüllt:
declare herewith under the sole responsibility that the object of this declaration is in conformity with the following relevant Union harmonization legislation:

(A)

ATEX-Richtlinie 2014/34/EU

ATEX-Directive 2014/34/EU

Gerät: <i>Equipment:</i>	Zündschutzart: <i>Type of protection:</i>	EU - Baumusterprüfbescheinigung* <i>EU-type examination certificate</i>
MultiTask Typ MT.-RMTT-H	II 2 G Ex eb ib [ib] mb IIB T4 Gb	TÜV 13 ATEX 126067
MultiTask Typ MT.-HZMI-L	II 2 G Ex eb ib mb IIC T4 Gb	

* einschließlich aller Ergänzungen / including all supplements

Grundlegende Normen:..... EN 60079-0:2018; EN 60079-7:2015;
Basic standards: EN60079-11:2012; 60079-0:2015/A1:2017/AC:2018

Andere angewandte Bestimmungen / EU-Richtlinien:.....
Other applied regulations / EU-Directives:

Benannte Stelle / Produktionsüberwachung: PTB (0102)
Notified Body Production control

Prüfungen/Überwachung/Kontrollen während der Fertigung: .. Hersteller
Examination/inspection/tests during manufacturing: Manufacturer

Die zugehörige Betriebsanleitung enthält wichtige sicherheitstechnische Hinweise und Vorschriften für die Aufstellung, Inbetriebnahme, Wartung und Instandhaltung der (s) Gerät(es).

The appropriate operator's manual contains important safety technical notes and regulations for the installation, placing into operation, maintenance and maintenance of the equipment.

(B)

EMV-Richtlinie 2014/30/EU

EMC-Directive 2014/30/EU

Zur Beurteilung des Erzeugnisses hinsichtlich der elektromagnetischen Verträglichkeit wurden die folgenden Vorschriften angewendet:

For verification of conformity with the protection requirements, the following standard is applied:

Grundlegende Norm:..... EN 61000-6-3
Basic standard:

No. of document: KEel 360-5

page 1 of 2

KEel 360-5**(C) ROHS-Richtlinie 2011/65/EU***ROHS-Directive 2011/65/EU*

Der oben beschriebene Gegenstand der Erklärung erfüllt die Vorschriften der Richtlinie 2011/65/EU des Europäischen Parlaments und des Rates vom 8. Juni 2011 zur Beschränkung der Verwendung bestimmter gefährlicher Stoffe in Elektro- und Elektronikgeräten

The object of the declaration described above is in conformity with Directive 2011/65/EU of the European Parliament and of the Council of 8 June 2011 on the restriction of the use of certain hazardous substances in electrical and electronic equipment

(D) RE-D richtlinie 2014/53/EU*RE-D-Directive 2014/53/EU*

Der oben beschriebene Gegenstand der Erklärung erfüllt die Vorschriften der Richtlinie 2014/53/EU des Europäischen Parlaments über die Bereitstellung von Funkanlagen auf dem Markt.

The object of the declaration described above is in conformity with Directive 2014/53/EU of the European Parliament on the making available on the market of radio equipment.

Angewandte Normen (abhängig von der Ausführung) / *used standards (depending on the type)*

Safety of information technology equipment.....	EN60950-1 :A 12:2011
EMC for broadband data transmission systems.....	EN 301 489-1 v2.1. 1; -17 v3.1.1;-52 V1 .1.1 EN 301 489 -1 V2.2.0; -19 V2.1.1
Spectrum for wideband transmission systems.....	EN 300 328 v2.1.1, EN 301 511 V9.0.2 EN 303 413 V1.1 .0

Ort und Datum: Ellerbek, 01.12.2021
Location and date

Geschäftsführer
General Manager



(Nikhil Chzube)

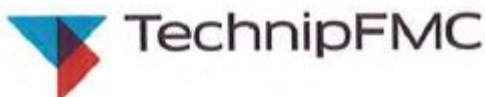

F.A. Sening GmbH
Ellerbek, Germany

EU-Konformitätserklärung Nr.: KEel 010-5
EU-Declaration of Conformity no.:

Der Hersteller/ The Manufacturer

F.A. Sening GmbH, Regentstraße 1, 25474 Ellerbek

erklärt hiermit in alleiniger Verantwortung, dass der Gegenstand der nachfolgenden Erklärung die einschlägigen Rechtsvorschriften zur Harmonisierung in der Union erfüllt:
declare herewith under the sole responsibility that the object of the declaration described below is in conformity with the relevant Union harmonization legislation:

(A) ATEX-Richtlinie 2014/34/EU
ATEX-Directive 2014/34/EU

Produkt: <i>Product:</i>	Zündschutzart: <i>Type of protection:</i>	EU – Baumusterprüfbescheinigung* <i>EU-type examination certificate</i>
Bediengerät Typ GD1.-	⊕ II 2 G Ex ib IIB T4	TÜV 97 ATEX 1175
Steuergerät MultiFlow	⊕ II 2 G Ex d [ib] IIB T4	TÜV 97 ATEX 1176

*einschließlich aller Ergänzungen / *including all supplements*

Grundlegende Normen:.....EN 60079-0:2018; EN 60079-1:2015;
Basic standards: EN 60079-11:2012

Andere angewandte Bestimmungen / EU-Richtlinien:
Other applied regulations / EU-Directives:

Benannte Stelle / Produktionsüberwachung: PTB (0102)
Notified Body Production control

Prüfungen/Überwachung/Kontrollen während der Fertigung: .. Hersteller
Examination/inspection/tests during manufacturing: Manufacturer

Die zugehörige Betriebsanleitung enthält wichtige sicherheitstechnische Hinweise und Vorschriften für die Aufstellung, Inbetriebnahme, Wartung und Instandhaltung der (s) Gerät(es).
The appropriate operator's manual contains important safety technical notes and regulations for the installation, placing into operation, maintenance and maintenance of the equipment.



(B) EMV-Richtlinie 2014/30/EU
EMC-Directive 2014/30/EU

Zur Beurteilung des Erzeugnisses hinsichtlich der Elektromagnetischen Verträglichkeit wurden die folgenden Vorschriften angewendet:
For verification of conformity with the protection requirements, the following standard is applied:

Grundlegende Norm:..... EN61000-6-3
Basic standard:

(C) ROHS-Richtlinie 2011/65/EU
ROHS-Directive 2011/65/EU

Der oben beschriebene Gegenstand der Erklärung erfüllt die Vorschriften der Richtlinie 2011/65/EU des Europäischen Parlaments und des Rates vom 8. Juni 2011 zur Beschränkung der Verwendung bestimmter gefährlicher Stoffe in Elektro- und Elektronikgeräten
The object of the declaration described above is in conformity with Directive 2011/65/EU of the European Parliament and of the Council of 8 June 2011 on the restriction of the use of certain hazardous substances in electrical and electronic equipment

Ort und Datum; Ellerbek, 01.12.2021
Location and date

Geschäftsführer
General Manager (Nikhil Chaube)



F.A. Sening GmbH
Ellerbek, Germany

Herstellereklärung Nr.: HEme 150-4
Manufacturer declaration no.:

Der Hersteller / The Manufacturer

F.A. Sening GmbH, Regentstraße 1, 25474 Ellerbek

erklärt hiermit, dass die folgenden Betriebsmittel der Bauart
herewith we declare, that the following equipment of the design

Druckschalter, Typ: <i>pressure switches, type:</i>	352347, P8000005275
--	---------------------

, eingesetzt in den Geräten MSDSO, NM2DSS und 352346, für die Verwendung in explosionsgefährdeter Atmosphäre der Zone 1 geeignet sind.

, used in the devices MSDSO, NM2DSS and 352346 are suitable for use in Zone 1 potentially explosive atmospheres.

Grundlage ist der einfache Aufbau gemäß IEC/EN 60079-11, Abschnitt 5.7 „Einfache elektrische Betriebsmittel“. Die Betriebsmittel sind mit einem pneumatisch angetriebenen Schalter und wahlweise mit 2 zusätzlichen Widerständen aufgebaut. Bei der Verwendung einer zugelassenen, eigensicheren Stromversorgung und unter Berücksichtigung der im Folgenden genannten sicherheitstechnischen Maximalwerte werden die grundlegenden Anforderungen der Norm erfüllt.

The basis is the simple design according to IEC / EN 60079-11, section 5.7 "Simple apparatus". The apparatus is constructed with a pneumatically driven switch, optional with 2 additional resistors. The essential requirements of the standard are fulfilled when using an approved intrinsically safe power supply by considering the safety-related maximum values specified below.

Die sicherheitstechnischen Nennwerte der oben genannten Betriebsmittel betragen
The nominal safety-related values of the above-mentioned equipment are

$$U_i = 15V \mid I_i = 176 \text{ mA} \mid P_i = 0,66 \text{ W} \mid L_i \sim 0 \mu\text{H} \mid C_i \sim 0 \mu\text{F}$$

Unter Anwendung dieser Nennwerte ergibt sich einer Temperaturerhöhung von 33 K. Bei einem zulässigen Temperaturbereich von -20 °C bis +60 °C ist die Einstufung in die Temperaturklasse T5 zulässig.

By applying the nominal values there is a temperature increase of 33 K. In the temperature range of -20 °C to +60 °C it is permissible to declare the equipment temperature class T5.

Ort und Datum: Ellerbek, den 01.12.2021
Location and date

Geschäftsführer
General Manager

(Nikhil Chaube)



F.A. Sening GmbH
Ellerbek, Germany

EU-Konformitätserklärung Nr.: **KEel 070-4**
EU-Declaration of Conformity no.:

Der Hersteller/ The Manufacturer

F.A. Sening GmbH, Regentstraße 1, 25474 Ellerbek

erklärt hiermit in alleiniger Verantwortung, dass der Gegenstand der nachfolgenden Erklärung die einschlägigen Rechtsvorschriften zur Harmonisierung in der Union erfüllt:
declare herewith under the sole responsibility that the object of the declaration described below is in conformity with the relevant Union harmonization legislation:

(A) ATEX-Richtlinie 2014/34/EU
ATEX-Directive 2014/34/EU

Produkt: <i>Product:</i>	Zündschutzart: <i>Type of protection:</i>	FU - Baumusterprüfbescheinigung* <i>EU - type examination certificate</i>
Überwachungssensor Typ INS1...-...	II 2 G or II 1/2 G Ex ia IIC T4 Gb or Ga/Gb	PTB 03 ATEX 2013

**einschließlich aller Ergänzungen / including all supplements*

Grundlegende Normen:..... EN 60079-0:2012+ A11:2013; EN 60079-11:2012;
Basic standards EN 60079-26:2015

Andere angewandte Bestimmungen / EU-Richtlinien:
Other applied regulations / EU-Directives:

Benannte Stelle / Produktionsüberwachung: PTB (0102)
*Notified Body Production control**

Prüfungen/Überwachung/Kontrollen während der Fertigung: .. Hersteller
Examination/inspection/tests during manufacturing: Manufacturer

Die zugehörige Betriebsanleitung enthält wichtige sicherheitstechnische Hinweise und Vorschriften für die Aufstellung, Inbetriebnahme, Wartung und Instandhaltung der (s) Gerät(es).
The appropriate operator's manual contains important safety technical notes and regulations for the installation, placing into operation, maintenance and maintenance of the equipment.



(B) EMV-Richtlinie 2014/30/EU
EMC-Directive 2014/30/EU

Zur Beurteilung des Erzeugnisses hinsichtlich der Elektromagnetischen Verträglichkeit wurden die folgenden Vorschriften angewendet:

For verification of conformity with the protection requirements, the following standard is applied:

Grundlegende Norm:..... EN61000-6-3
Basic standard:

(C) ROHS-Richtlinie 2011/65/EU
ROHS-Directive 2011/65/EU

Der oben beschriebene Gegenstand der Erklärung erfüllt die Vorschriften der Richtlinie 2011/65/EU des Europäischen Parlaments und des Rates vom 8. Juni 2011 zur Beschränkung der Verwendung bestimmter gefährlicher Stoffe in Elektro- und Elektronikgeräten

The object of the declaration described above is in conformity with Directive 2011/65/EU of the European Parliament and of the Council of 8 June 2011 on the restriction of the use of certain hazardous substances in electrical and electronic equipment

Ort und Datum: Ellerbek, 01.12.2021
Location and date

Geschäftsführer 
General Manager (Nikhil Chaube)

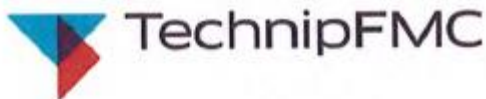

F.A. Sening GmbH
Ellerbek, Germany

EU-Konformitätserklärung Nr.: KEel 290-4
EU-Declaration of Conformity no.:

Der Hersteller/ The Manufacturer

F.A. Sening GmbH, Regentstraße 1, 25474 Ellerbek

erklärt hiermit in alleiniger Verantwortung, dass der Gegenstand der nachfolgenden Erklärung die einschlägigen Rechtsvorschriften zur Harmonisierung in der Union erfüllt:
declares herewith under the sole responsibility that the object of the declaration described below is in conformity with the relevant Union harmonization legislation:

(A) ATEX-Richtlinie 2014/34/EU
ATEX-Directive 2014/34/EU

Produkt: <i>Product:</i>	Zündschutzart: <i>Type of protection:</i>	EU - Baumusterprüfbescheinigung* <i>EU-type examination certificate</i>
NS-2...	Ex II 2 G Ex Ia op is IIB T4 Ga	TUV 05 ATEX 1982

**einschließlich aller Ergänzungen / including all supplements*

Grundlegende Normen: EN 60079-0; EN 60079-11; EN 60079-26
Basic standards:

Andere angewandte Bestimmungen / EU-Richtlinien:
Other applied regulations / EU-Directives:

Benannte Stelle / Produktionsüberwachung: PTB (0102)
Notified Body Production control

Prüfungen/Überwachung/Kontrollen während der Fertigung: .. Hersteller
Examination/inspection/tests during manufacturing: Manufacturer

Die zugehörige Betriebsanleitung enthält wichtige sicherheitstechnische Hinweise und Vorschriften für die Aufstellung, Inbetriebnahme, Wartung und Instandhaltung der (s) Gerät(es).
The appropriate operator's manual contains important safety technical notes and regulations for the installation, placing into operation, maintenance and maintenance of the equipment.



(B) EMV-Richtlinie 2014/30/EU
EMC-Directive 2014/30/EU

Zur Beurteilung des Erzeugnisses hinsichtlich der Elektromagnetischen Verträglichkeit wurden die folgenden Vorschriften angewendet:

For verification of conformity with the protection requirements, the following standard is applied:

Grundlegende Norm:..... EN61000-6-3
Basic standard:

(C) ROHS-Richtlinie 2011/65/EU
ROHS-Directive 2011/65/EU

Der oben beschriebene Gegenstand der Erklärung erfüllt die Vorschriften der Richtlinie 2011/65/EU des Europäischen Parlaments und des Rates vom 8. Juni 2011 zur Beschränkung der Verwendung bestimmter gefährlicher Stoffe in Elektro- und Elektronikgeräten

The object of the declaration described above is in conformity with Directive 2011/65/EU of the European Parliament and of the Council of 8 June 2011 on the restriction of the use of certain hazardous substances in electrical and electronic equipment

Ort und Datum: Ellerbek, 01.12.2021
Location and date

Geschäftsführer
General Manager

(Nikhil Chaube)



F.A. Sening GmbH
Ellerbek, Germany

EU-Konformitätserklärung Nr.:
EU-Declaration of Conformity no.:

KEel 320-4

Der Hersteller/ The Manufacturer

F.A. Sening GmbH, Regentstraße 1, 25474 Ellerbek

erklärt hiermit in alleiniger Verantwortung, dass der Gegenstand der nachfolgenden Erklärung die einschlägigen Rechtsvorschriften zur Harmonisierung in der Union erfüllt:
declare herewith under the sole responsibility that the object of the declaration described below is in conformity with the relevant Union harmonization legislation:

(A)

ATEX-Richtlinie 2014/34/EU

ATEX-Directive 2014/34/EU

Produkt: <i>Product:</i>	Zündschutzart: <i>Type of protection:</i>	EU - Baumusterprüfbescheinigung* <i>EU-type examination certificate</i>
NM2-WET	 II 2 G Ex eb Ia [Ia] mb IIB T4	TUV 00 ATEX 1603

*einschließlich aller Ergänzungen / *including all supplements*

Grundlegende Normen: EN 60079-0; EN 60079-7; EN 60079-11; EN 60079-18
Basic standards:

Andere angewandte Bestimmungen / EU-Richtlinien:
Other applied regulations / EU-Directives:

Benannte Stelle / Produktionsüberwachung: PTB (0102)
Notified Body Production control

Prüfungen/Überwachung/Kontrollen während der Fertigung: .. Hersteller
Examination/inspection/tests during manufacturing: Manufacturer

Die zugehörige Betriebsanleitung enthält wichtige sicherheitstechnische Hinweise und Vorschriften für die Aufstellung, Inbetriebnahme, Wartung und Instandhaltung der (s) Gerät(es).
The appropriate operator's manual contains important safety technical notes and regulations for the installation, placing into operation, maintenance and maintenance of the equipment.



(B)

EMV-Richtlinie 2014/30/EU

EMC-Directive 2014/30/EU

Zur Beurteilung des Erzeugnisses hinsichtlich der Elektromagnetischen Verträglichkeit wurden die folgenden Vorschriften angewendet:

For verification of conformity with the protection requirements, the following standard is applied:

Grundlegende Norm:..... EN61000-6-3
Basic standard:

(C)

ROHS-Richtlinie 2011/65/EU

ROHS-Directive 2011/65/EU

Der oben beschriebene Gegenstand der Erklärung erfüllt die Vorschriften der Richtlinie 2011/65/EU des Europäischen Parlaments und des Rates vom 8. Juni 2011 zur Beschränkung der Verwendung bestimmter gefährlicher Stoffe in Elektro- und Elektronikgeräten

The object of the declaration described above is in conformity with Directive 2011/65/EU of the European Parliament and of the Council of 8 June 2011 on the restriction of the use of certain hazardous substances in electrical and electronic equipment

Ort und Datum: Ellerbek, 01.12.2021
Location and date

Geschäftsführer
General Manager

(Nikhil Chaube)

No. of document: KEel 320-4

page 1 of 1

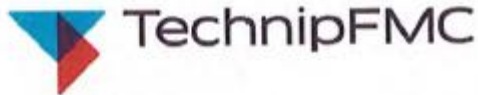

F.A. Sening GmbH
Ellerbek, Germany

EU-Konformitätserklärung Nr.:

KEel 330-4

EU-Declaration of Conformity no.:

Der Hersteller/ The Manufacturer

F.A. Sening GmbH, Regentstraße 1, 25474 Ellerbek

erklärt hiermit in alleiniger Verantwortung, dass der Gegenstand der nachfolgenden Erklärung die einschlägigen Rechtsvorschriften zur Harmonisierung in der Union erfüllt:
declare herewith under the sole responsibility that the object of the declaration described below is in conformity with the relevant Union harmonization legislation:

(A) ATEX-Richtlinie 2014/34/EU
ATEX-Directive 2014/34/EU

Produkt: <i>Product:</i>	Zündschutzart: <i>Type of protection:</i>	EU - Baumusterprüfbescheinigung* <i>EU-type examination certificate</i>
MSSPD-N	II 2 G Ex mb eb ia [ia] IIB T4	TUV 00 ATEX 1602

**einschließlich aller Ergänzungen / including all supplements*

Grundlegende Normen: EN 60079-0; EN-60079-7; EN 60079-11; EN 60079-18
Basic standards:

Andere angewandte Bestimmungen / EU-Richtlinien:
Other applied regulations / EU-Directives:

Benannte Stelle / Produktionsüberwachung: PTB (0102)
Notified Body Production control

Prüfungen/Überwachung/Kontrollen während der Fertigung: ... Hersteller
Examination/inspection/tests during manufacturing: Manufacturer

Die zugehörige Betriebsanleitung enthält wichtige sicherheitstechnische Hinweise und Vorschriften für die Aufstellung, Inbetriebnahme, Wartung und Instandhaltung der (s) Gerät(ess).
The appropriate operator's manual contains important safety technical notes and regulations for the installation, placing into operation, maintenance and maintenance of the equipment.



(B) EMV-Richtlinie 2014/30/EU
EMC-Directive 2014/30/EU

Zur Beurteilung des Erzeugnisses hinsichtlich der Elektromagnetischen Verträglichkeit wurden die folgenden Vorschriften angewendet:
For verification of conformity with the protection requirements, the following standard is applied:

Grundlegende Norm:..... EN61000-6-3
Basic standard:

(C) ROHS-Richtlinie 2011/65/EU
ROHS-Directive 2011/65/EU

Der oben beschriebene Gegenstand der Erklärung erfüllt die Vorschriften der Richtlinie 2011/65/EU des Europäischen Parlaments und des Rates vom 8. Juni 2011 zur Beschränkung der Verwendung bestimmter gefährlicher Stoffe in Elektro- und Elektronikgeräten
The object of the declaration described above is in conformity with Directive 2011/65/EU of the European Parliament and of the Council of 8 June 2011 on the restriction of the use of certain hazardous substances in electrical and electronic equipment

Ort und Datum: Ellerbek, 01.12.2021
Location and date

Geschäftsführer
General Manager

(Nikhil Chaube)

No. of document: KEel 330-4

page 1 of 1



F.A. Sening GmbH
Ellerbek, Germany

EU-Konformitätserklärung Nr.: KEel 390-2
EU-Declaration of Conformity no.:

Der Hersteller / The Manufacturer

F.A. Sening GmbH, Regentstraße 1, 25474 Ellerbek

erklärt hiermit in alleiniger Verantwortung, dass der Gegenstand der nachfolgenden Erklärung die einschlägigen Rechtsvorschriften zur Harmonisierung in der Union erfüllt:
declare herewith under the sole responsibility that the object of the declaration described below is in conformity with the relevant Union harmonization legislation:

(A) ATEX-Richtlinie 2014/34/EU
ATEX-Directive 2014/34/EU

Produkt: <i>Product:</i>	Zündschutzart: <i>Type of protection:</i>	EU - Baumusterprüfbescheinigung* <i>EU - type examination certificate</i>
NM2-RFID-...	(Ex) 2 G Ex ia/ib mb IIB T4	TÜV 07 ATEX 344782

*einschließlich aller Ergänzungen / *including all supplements*

Grundlegende Normen: EN 60079-0:2012 + A11:2013; EN 60079-11:2012
Basic standards: EN 60079-18:2015

Andere angewandte Bestimmungen / EU-Richtlinien:.....
Other applied regulations / EU-Directives:

Benannte Stelle / Produktionsüberwachung: PTB (0102)
Notified Body Production control

Prüfungen/Überwachung/Kontrollen während der Fertigung: .. Hersteller
Examination/inspection/tests during manufacturing: Manufacturer

Die zugehörige Betriebsanleitung enthält wichtige sicherheitstechnische Hinweise und Vorschriften für die Aufstellung, Inbetriebnahme, Wartung und Instandhaltung der (s) Gerät(es).
The appropriate operator's manual contains important safety technical notes and regulations for the installation, placing into operation, maintenance and maintenance of the equipment.



(B) EMV-Richtlinie 2014/30/EU
EMC-Directive 2014/30/EU

Zur Beurteilung des Erzeugnisses hinsichtlich der Elektromagnetischen Verträglichkeit wurden die folgenden Vorschriften angewendet:
For verification of conformity with the protection requirements, the following standard is applied:

Grundlegende Norm:..... EN 61000-6-3
Basic standard:

(C) ROHS-Richtlinie 2011/65/EU
ROHS-Directive 2011/65/EU

Der oben beschriebene Gegenstand der Erklärung erfüllt die Vorschriften der Richtlinie 2011/65/EU des Europäischen Parlaments und des Rates vom 8. Juni 2011 zur Beschränkung der Verwendung bestimmter gefährlicher Stoffe in Elektro- und Elektronikgeräten
The object of the declaration described above is in conformity with Directive 2011/65/EU of the European Parliament and of the Council of 8 June 2011 on the restriction of the use of certain hazardous substances in electrical and electronic equipment

1

KEel 390-2**(D)****RE-D Richtlinie 2014/53/EU***RE-D Directive 2014/53/EU*

Der oben beschriebene Gegenstand der Erklärung erfüllt die Vorschriften der Richtlinie 2014/53/EU des Europäischen Parlaments über die Bereitstellung von Funkanlagen auf dem Markt.
The object of the declaration described above is in conformity with Directive 2014/53/EU of the European Parliament on the making available on the market of radio equipment.

Angewandte Normen (*abhängig von der Ausführung*) / *used standards (depending on the type)*

Safety of information technology equipment..... covered by EN 60079-0

EMC for broadband data transmission systems EN 300 330 V2, 1.11

Ort und Datum: Ellerbek, 01.12.2021
Location and date

Geschäftsführer
General Manager

(Nikhil Chaube)

Subject to technical changes.

Sening® is a registered trademark of FMC Technologies Inc.

Up-to-date contact information can be found on our website: www.fmctechnologies.com/measurementsolutions under "Contact Us" in the left-hand navigation column.

Headquarters:

500 North Sam Houston Parkway West, Suite 100 Houston, TX 77067 USA, Phone: +1 (281) 260 2190, Fax: +1 (281) 260 2191

Measurement Products and Equipment:

Erie, PA USA +1 (814) 898 5000

Ellerbek, Germany +49 (4101) 3040

Barcelona, Spain +34 (93) 201 0989

Beijing, China +86 (10) 6500 2251

Buenos Aires, Argentina +54 (11) 4312 4736

Burnham, England +44 (1628) 603205

Dubai, United Arab Emirates +971 (4) 883 0303

Los Angeles, CA USA +1 (310) 328 1236

Melbourne, Australia +61 (3) 9807 2818

Moscow, Russia +7 (495) 5648705

Singapore +65 6861 3011

Integrated Measurement Systems:

Corpus Christi, TX USA +1 (361) 289 3400

Kongsberg, Norway +47 (32) 28 67 00

San Juan, Puerto Rico +1 (787) 772 8100

Dubai, United Arab Emirates +971 (4) 883 0303

For further information about Sening® products, please visit: www.fmctechnologies.com/measurementsolutions